

Timing Generator for Color LCD Panels

Description

The CXD2411AR is a timing signal generator for color LCD panel drivers.

Features

- Generates the LCX005BK/BKB and LCX009AK/AKB drive pulse.
- Supports right/left inverse display.
- Supports 16:9 wide display.
- Supports CSYNC and Separate SYNC (XHD, XVD) input.
- Supports line inversion and field inversion.
- AC drive for LCD panel during no signal (NTSC/PAL).
- Generates timing signal of external sample-and-hold circuit.
- AFC circuit supporting static and dynamic fluctuations.

Applications

- Color LCD viewfinder
- Single-panel and three-panel projectors

Structure

Silicon gate CMOS IC

48 pin LQFP (Plastic)

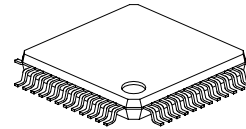

Absolute Maximum Ratings (Ta = 25°C)

- | | | | |
|-------------------------|------------------|--|----|
| • Supply voltage | V _{DD} | V _{SS} – 0.5 to +7.0 | V |
| • Input voltage | V _I | V _{SS} – 0.5 to V _{DD} + 0.5 | V |
| • Output voltage | V _O | V _{SS} – 0.5 to V _{DD} + 0.5 | V |
| • Operating temperature | T _{opr} | –20 to +85 | °C |
| • Storage temperature | T _{stg} | –55 to +150 | °C |

Recommended Operating Conditions

- | | | | |
|-------------------------|------------------|------------|----|
| • Supply voltage | V _{DD} | 2.7 to 5.5 | V |
| • Operating temperature | T _{opr} | –20 to +85 | °C |

Sony reserves the right to change products and specifications without prior notice. This information does not convey any license by any implication or otherwise under any patents or other right. Application circuits shown, if any, are typical examples illustrating the operation of the devices. Sony cannot assume responsibility for any problems arising out of the use of these circuits.

Block Diagram and Pin Configuration

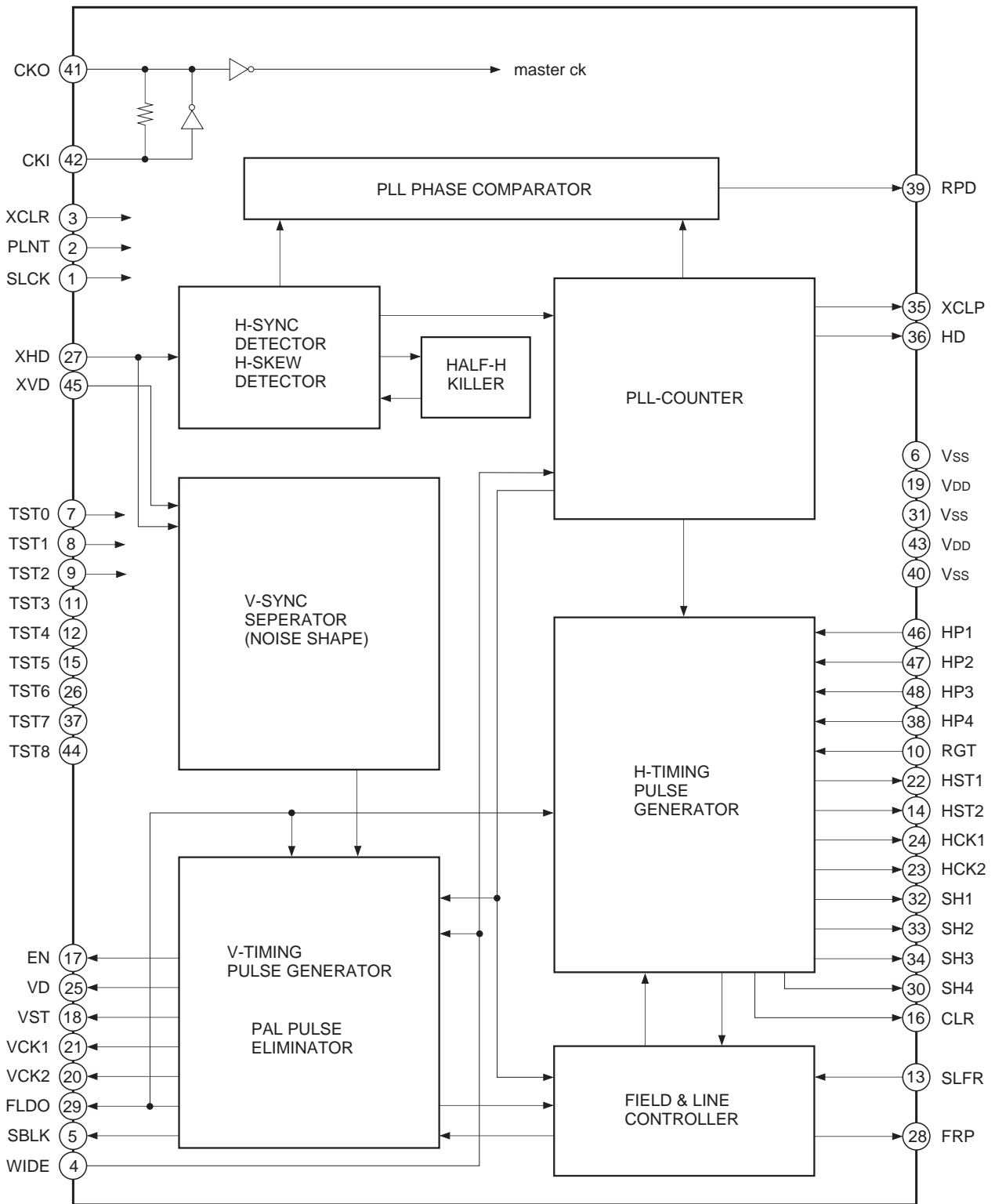

Pin Description

Pin No.	Symbol	I/O	Description	Input pin for open status
1	SLCK	I	Switches between LCX005BK (H) and LCX009 (L)	L
2	PLNT	I	Switches between PAL (H) and NTSC (L)	L
3	XCLR	I	Cleared at 0V	H
4	WIDE	I	Switches between 16:9 display (H) and 4:3 display (L)	L
5	SBLK	O	Black signal pulse output (during WIDE MODE) (positive polarity)	—
6	V _{SS}	—	GND	
7	TST0	—	Leave this open.	—
8	TST1	—	Leave this open.	—
9	TST2	—	Leave this open.	—
10	RGT	I	Switches between Normal scan (H) and Reverse scan (L)	H
11	TST3	—	Leave this open.	—
12	TST4	—	Leave this open.	—
13	SLFR	I	Switches between field inversion (H) and line inversion (L)	L
14	HST2	O	H start pulse 2 (positive polarity)	—
15	TST5	—	Leave this open.	—
16	CLR	O	CLR pulse output (positive polarity)	—
17	EN	O	EN pulse output (negative polarity)	—
18	VST	O	V start pulse (positive polarity)	—
19	V _{DD}	—	Power supply	
20	VCK2	O	V clock pulse 2	—
21	VCK1	O	V clock pulse 1	—
22	HST1	O	H start pulse 1 (positive polarity)	—
23	HCK2	O	H clock pulse 2	—
24	HCK1	O	H clock pulse 1	—
25	VD	O	VD pulse output (positive polarity)	—
26	TST6	—	Leave this open.	—
27	XHD	I	XHD (negative polarity)/Composite sync (positive polarity) input	—
28	FRP	O	AC drive timing pulse output	—
29	FLDO	O	Field identification signal output	—
30	SH4	O	Sample-and-hold pulse (positive polarity)	—
31	V _{SS}	—	GND	
32	SH1	O	Sample-and-hold pulse (positive polarity)	—
33	SH2	O	Sample-and-hold pulse (positive polarity)	—
34	SH3	O	Sample-and-hold pulse (positive polarity)	—
35	XCLP	O	Burst position clamp pulse output (negative polarity)	—
36	HD	O	HD pulse output (positive polarity)	—
37	TST7	—	Leave this open.	—

Pin No.	Symbol	I/O	Description	Input pin for open status
38	HP4	I	Switches for the horizontal display position	H
39	RPD	O	Phase comparator output	—
40	V _{SS}	—	GND	
41	CKO	O	Oscillation cell (output)	—
42	CKI	I	Oscillation cell (input)	—
43	V _{DD}	—	Power supply	
44	TST8	—	Leave this open.	—
45	XVD	I	XVD (negative polarity) input	L
46	HP1	I	Switches for the horizontal display position	L
47	HP2	I	Switches for the horizontal display position	L
48	HP3	I	Switches for the horizontal display position	L

(H: Pull up, L: Pull down)

Note) The CXD2411AR processes CSYNC and Separate SYNC inputs with the same pins. Therefore, care should be given to the following points when using the CXD2411AR.

- 1) During CSYNC input, the XVD input pin should be set to L or left open.
- 2) During Separate SYNC input (XHD, XVD), the XVD width specification is from 2H to 10H.

Electrical Characteristics

1. DC characteristics

(Temperature = 25°C, V_{SS} = 0V)

Item	Symbol	Conditions	Min.	Typ.	Max.	Unit
Supply voltage	V _{DD}		2.7		5.5	V
Input voltage	V _{IH}	TTL input cell (5V ±10%)	2.2			V
Input voltage	V _{IH}	TTL input cell (3.0V ±10%)	1.8			V
Input voltage	V _{IL}	TTL input cell			0.8	V
Input voltage	V _{IH}	CMOS input cell	0.7V _{DD}			V
Input voltage	V _{IL}	CMOS input cell			0.3V _{DD}	V
Output voltage	V _{OH}	I _{OH} = -4mA (HCKn, VCKn)	V _{DD} - 0.8			V
Output voltage	V _{OL}	I _{OL} = 8mA (HCKn, VCKn)			0.4	V
Output voltage	V _{OH}	I _{OH} = -3mA (CKO, CKI)	V _{DD} /2			V
Output voltage	V _{OL}	I _{OL} = 3mA (CKO, CKI)			V _{DD} /2	V
Output voltage	V _{OH}	I _{OH} = -2mA (other than the above)	V _{DD} - 0.8			V
Output voltage	V _{OL}	I _{OL} = 4mA (other than the above)			0.4	V
Input leak current	I _L	Normal input pin	-10		10	μA
Input leak current	I _{IL}	With pull-up resistor	-12	-100	-240	μA
Input leak current	I _{IH}	With pull-down resistor	12	100	240	μA
Output leak current	I _{LZ}	RPDn, FPDn (at high impedance state)	-40		40	μA
Current consumption	I _{DD}	V _{DD} = 5.0V		25		mA

2. AC characteristics

(V_{DD} = 2.7 to 5.5V)

Item	Applicable pins	Symbol	Conditions	Min.	Typ.	Max.	Unit
Clock input cycle	CKI			60			ns
Cross-point time difference	HCK1, HCK2	Δt	CL = 30pF			10	ns
Cross-point time difference	VCK1, VCK2	Δt	CL = 30pF			10	ns
Output rise delay	HCKn, VCKn	t _{pr}	CL = 30pF			30	ns
Output fall delay	HCKn, VCKn	t _{pf}	CL = 30pF			25	ns
Output rise delay	Other than HCKn and VCKn	t _{pr}	CL = 30pF			40	ns
Output fall delay	Other than HCKn and VCKn	t _{pf}	CL = 30pF			22	ns
HCK1, SH1 delay time difference	HCK1, SH1	dt1	CL = 30pF	60		85	ns
HCK1, SH1 delay time difference	HCK1, SH1	dt2	CL = 30pF	60		95	ns
HCK2, SH1 delay time difference	HCK2, SH1	dt1	CL = 30pF	60		85	ns
HCK2, SH1 delay time difference	HCK2, SH1	dt2	CL = 30pF	60		95	ns
HCK1 Duty	HCK1	t _H /t _H + t _L	CL = 30pF	46		52	%
HCK2 Duty	HCK2	t _H /t _H + t _L	CL = 30pF	46		52	%

Note) n = 1, 2

Timing Definition

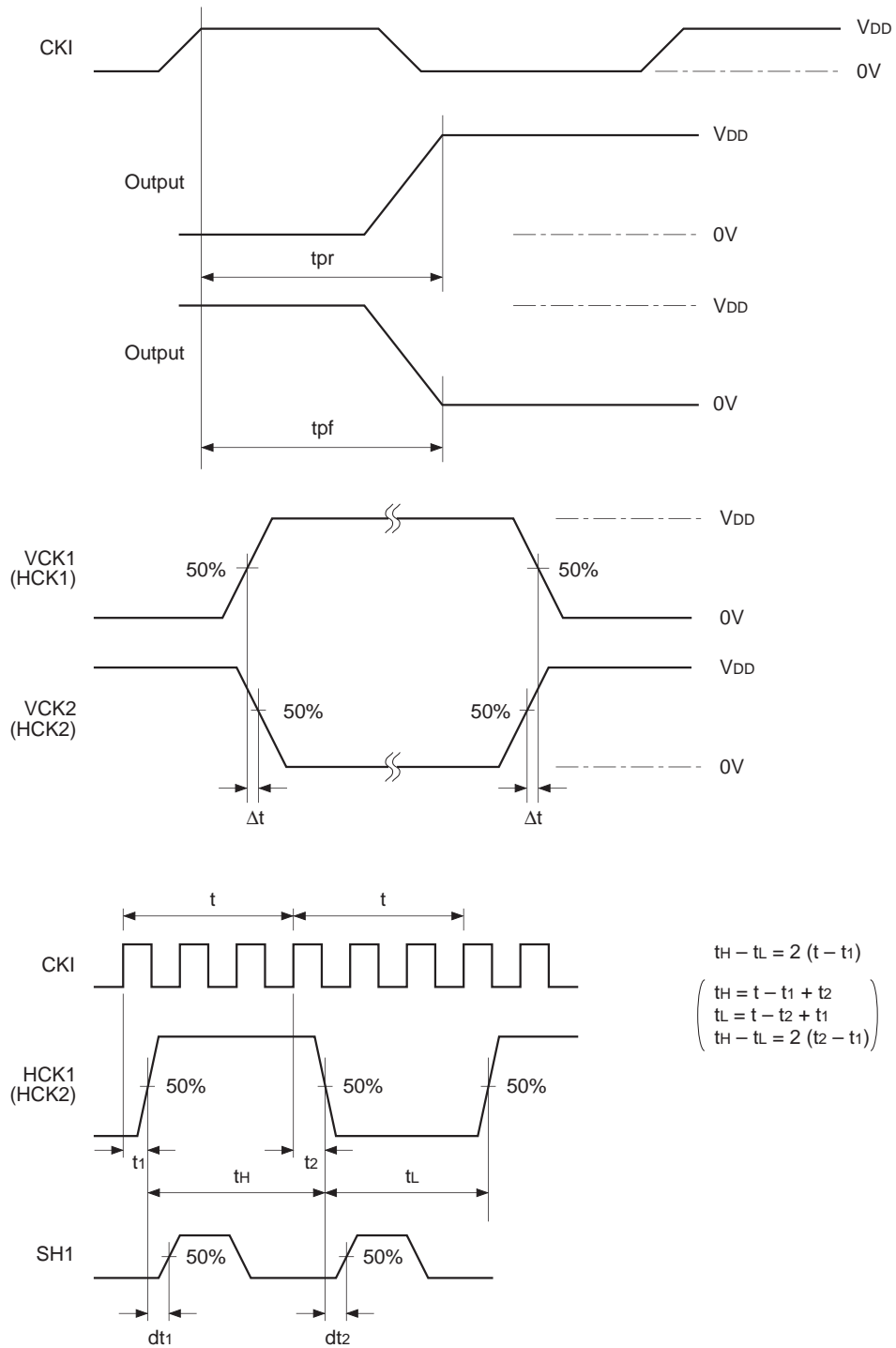

LCX005BK/BKB and LCX009AK/AKB Color Coding Diagram

The delta arrangement is used for the color coding in the LCD panels with which this IC is compatible. Note that the shaded region within the diagram is not displayed.

LCX005BK/BKB pixel arrangement

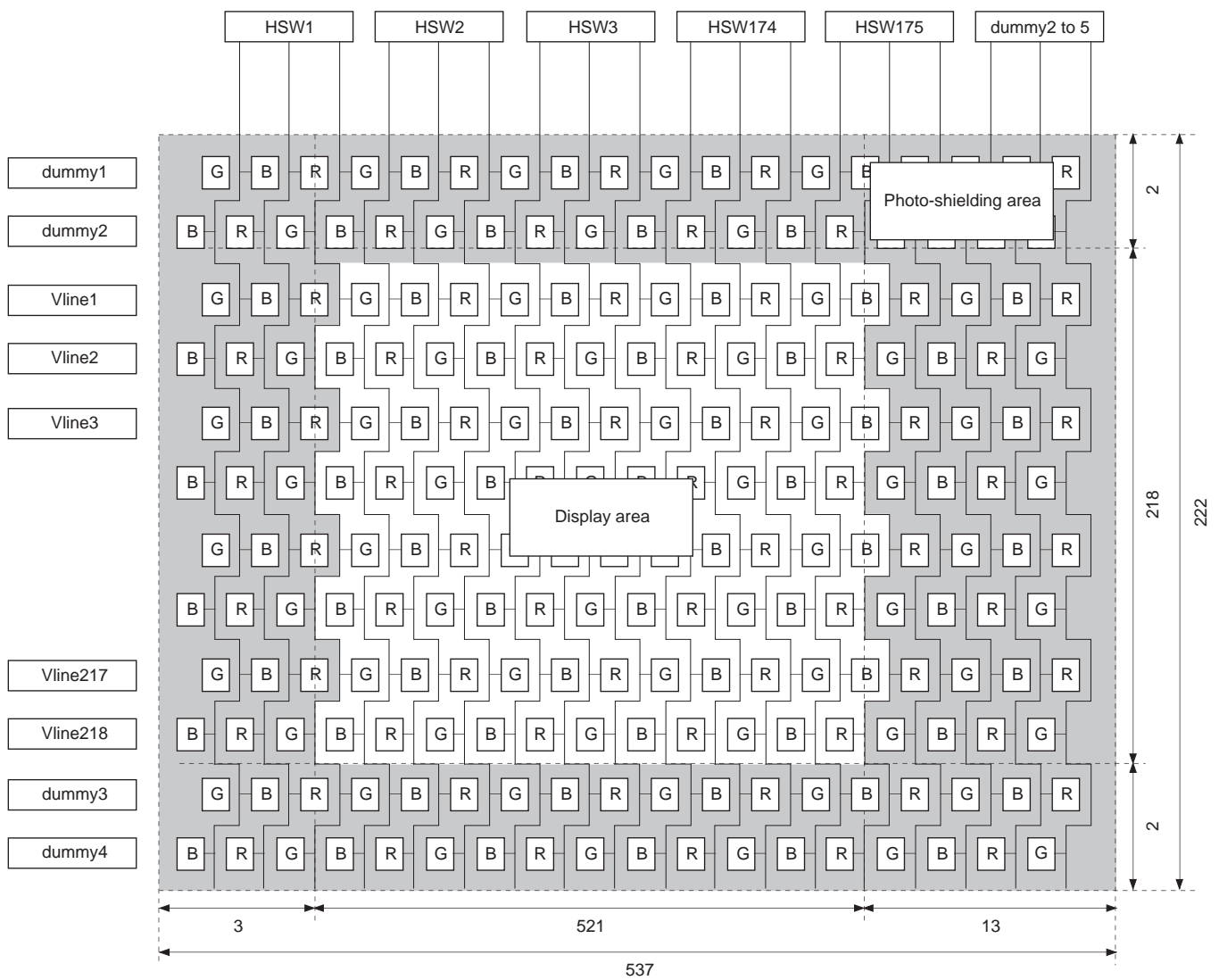

Basic specifications	
Total horizontal dots	: 537H
Horizontal display dots	: 521H
Total vertical dots	: 222H
Vertical display dots	: 218H
Total dots	: 119,214H
Display dots	: 113,578H

LCX009AK/AKB pixel arrangement

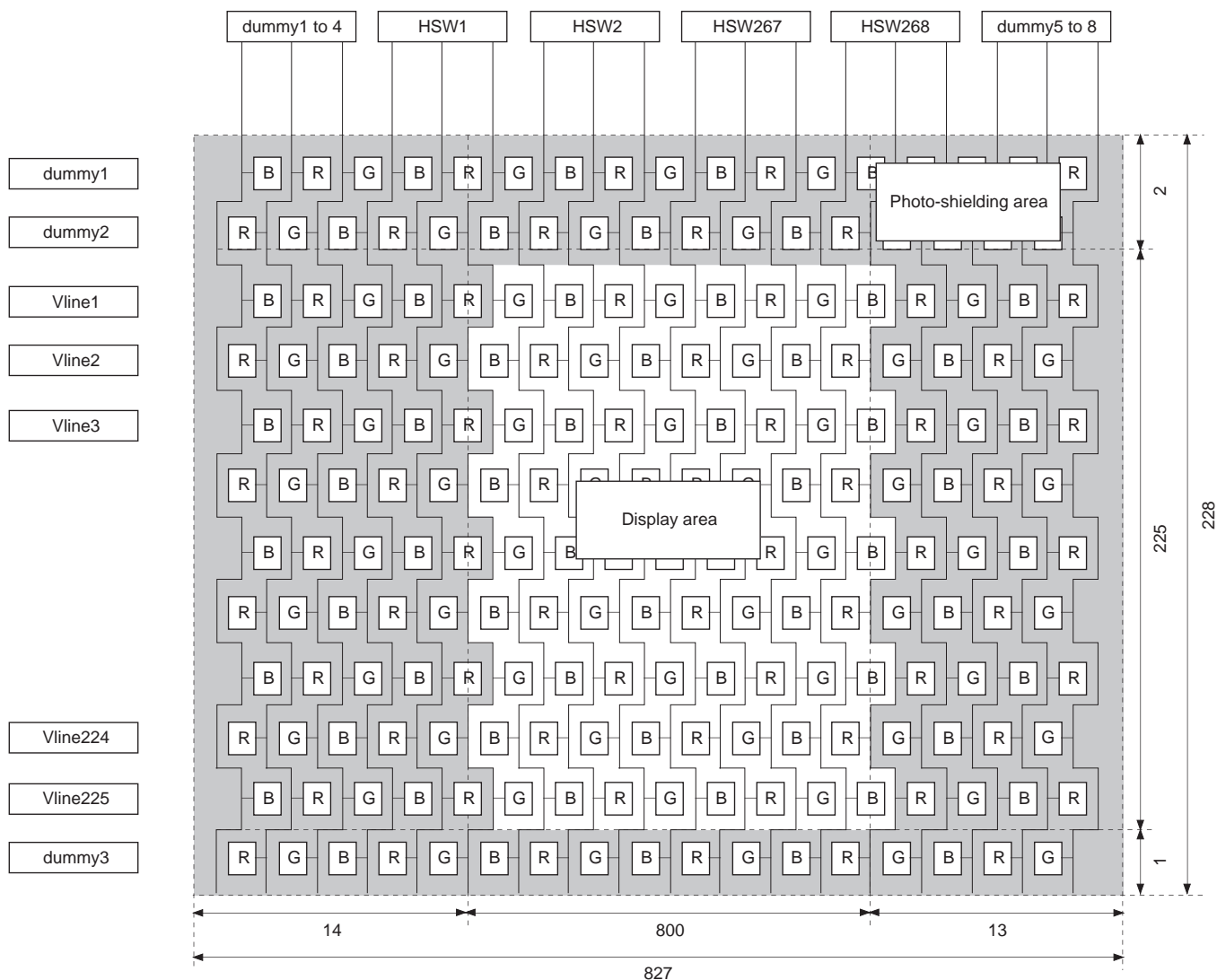

Basic specifications	
Total horizontal dots	: 827H
Horizontal display dots	: 800H
Total vertical dots	: 228H
Vertical display dots	: 225H
Total dots	: 188,556H
Display dots	: 180,000H

Description of Mode Selection Switch (SLCK, PLNT, WIDE)

SLCK	PLNT	WIDE	MODE
H	L	L	LCX005BK/BKB, NTSC, NORMAL
H	L	H	LCX005BK/BKB, NTSC, WIDE
H	H	L	LCX005BK/BKB, PAL, NORMAL
H	H	H	LCX005BK/BKB, PAL, WIDE
L	L	L	LCX009AK/AKB, NTSC, NORMAL
L	L	H	LCX009AK/AKB, NTSC, WIDE
L	H	L	LCX009AK/AKB, PAL, NORMAL
L	H	H	LCX009AK/AKB, PAL, WIDE

* NORMAL (4:3 display), WIDE (16:9 display)

SLFR

SLFR is the selector switch for the AC drive timing pulse (FRP). This switch selects field inversion when H and line inversion when L. Normally, line inversion (L) is used. The transition point is one clock cycle after the transition point of the VCK1 and VCK2 pulses.

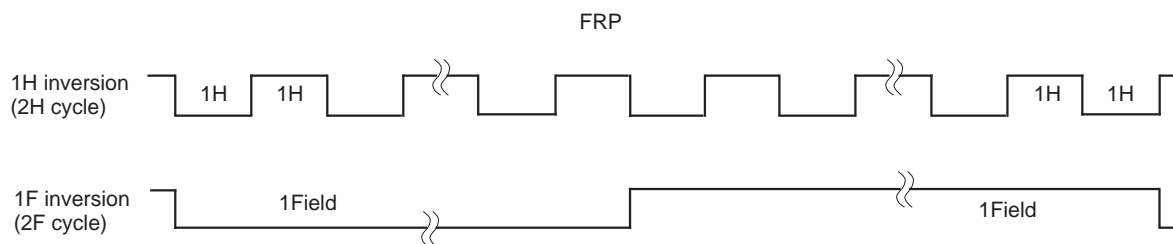

* FRP polarity is not specified.

HP1, 2, 3, 4

These are selector switches for the horizontal display position. The HST timing can be set at 2fh intervals in 16 different ways by using the four HST position bits. The picture center is set at internal preset value: HP1/2/3/4: LLLH. However, actually, because there is a difference between the RGB signal and the drive pulse delays, the picture center may not match the design center. In this case, adjust with these switches.

The HST timing (from SYNC termination to the rising edge of HST) for even lines is shown below.

LCX005BK/BKB (NTSC, PAL)

HP4	HP3	HP2	HP1	HST1 (NTSC/PAL)	HST2 (NTSC/PAL)
0	0	0	0	72fh (6.51/6.56μs)	74.5fh (6.74/6.79μs)
0	0	0	1	70fh	72.5fh
0	0	1	0	68fh	70.5fh
0	0	1	1	66fh	68.5fh
0	1	0	0	64fh	66.5fh
0	1	0	1	62fh	64.5fh
0	1	1	0	60fh	62.5fh
0	1	1	1	58fh	60.5fh
1	0	0	0	56fh (5.06/5.11μs)	58.5fh (5.29/5.33μs)
1	0	0	1	54fh	56.5fh
1	0	1	0	52fh	54.5fh
1	0	1	1	50fh	52.5fh
1	1	0	0	48fh	50.5fh
1	1	0	1	46fh	48.5fh
1	1	1	0	44fh	46.5fh
1	1	1	1	42fh (3.80/3.83μs)	44.5fh (4.02/4.06μs)

* The HST1 and 2 timing for odd lines is 1.5fh delayed and 1.5fh advanced respectively from the above timings. (Refer to the Timing Charts for details.)

LCX009AK/AKB (NTSC, PAL)

HP4	HP3	HP2	HP1	HST1 (NTSC/PAL)	HST2 (NTSC/PAL)
0	0	0	0	91fh (5.51/5.55 μ s)	93.5fh (5.66/5.70 μ s)
0	0	0	1	89fh	91.5fh
0	0	1	0	87fh	89.5fh
0	0	1	1	85fh	87.5fh
0	1	0	0	83fh	85.5fh
0	1	0	1	81fh	83.5fh
0	1	1	0	79fh	81.5fh
0	1	1	1	77fh	79.5fh
1	0	0	0	75fh (4.54/4.57 μ s)	77.5fh (4.69/4.72 μ s)
1	0	0	1	73fh	75.5fh
1	0	1	0	71fh	73.5fh
1	0	1	1	69fh	71.5fh
1	1	0	0	67fh	69.5fh
1	1	0	1	65fh	67.5fh
1	1	1	0	63fh	65.5fh
1	1	1	1	61fh (3.69/3.72 μ s)	63.5fh (3.84/3.87 μ s)

* The HST1 and 2 timing for odd lines is 1.5fh delayed and 1.5fh advanced respectively from the above timings. (Refer to the Timing Charts for details.)

Right/Left Inversion

The LCD panel is arranged in a delta pattern, where identical signal line has 1.5-dot offset at adjoining vertical lines. For this reason, a 1.5-bit offset is attached to the horizontal start pulse (HST) between odd lines and even lines. HCK and SH are also 1.5-bit offset in a similar manner.

When the panel is driven with left scan (Reverse scan), this offset relationship becomes inverted for even and odd lines. Moreover, since the dot arrangement is asymmetrical, the HST position is also changed. The CXD2411AR deals with this inversion as follows.

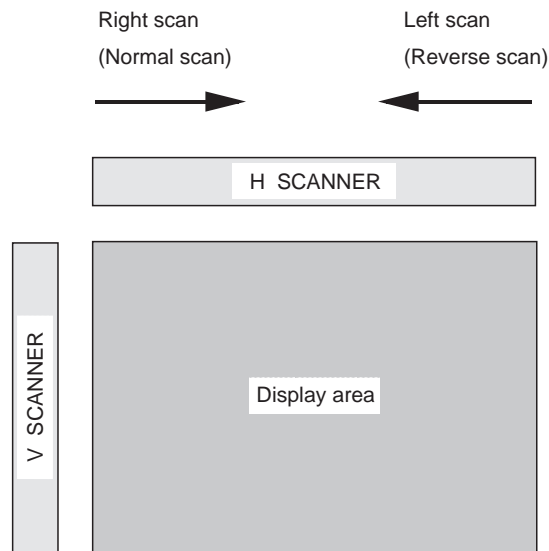

When using single-panel

- (1) When the right/left inversed-identification pin (RGT) goes L, the relationship concerning HCK output switches between odd and even lines. In this case, use HST1 for the horizontal direction start pulse.

When RGT is H:

Right scan mode is on. The right scan drive pulse is output by the timing generator and is supplied to the panel.

When RGT is L:

Left scan mode is on. The left scan drive pulse is output by the timing generator and is supplied to the panel.

When using three-panels

- (1) In order to be able to simultaneously drive three panels, with a mixture of right/left inversion on and off, output two pulses regarding HST pulse: HST1 for right scan (Normal scan) and HST2 for left scan (Reverse scan).

In addition, left and right scan outputs are necessary for the RGT signal as well. However, since this timing generator does not have an RGT (right/left inversed-identification) output pin for left scan, external measures must be taken. Similarly, external measures are also taken for HCK1 and 2.

Regarding SH, the wiring of SH1 and SH4 to the driver IC.

- (2) When the right/left inversed-identification pin (RGT) goes L, the relationship concerning HCK output switches between odd and even lines for each output switches.

When RGT is H:

Right scan mode is on. The right scan (A) and left scan (B) drive pulses are output by the timing generator and are supplied to panels 1 and 2 and panel 3, respectively.

When RGT is L:

Left scan mode is on and (A) and (B) outputs are switched. Accordingly, panels 1 and 2 are used for left scan and panel 3 changes to right scan.

Application Circuit (Three-panel LCD drive)

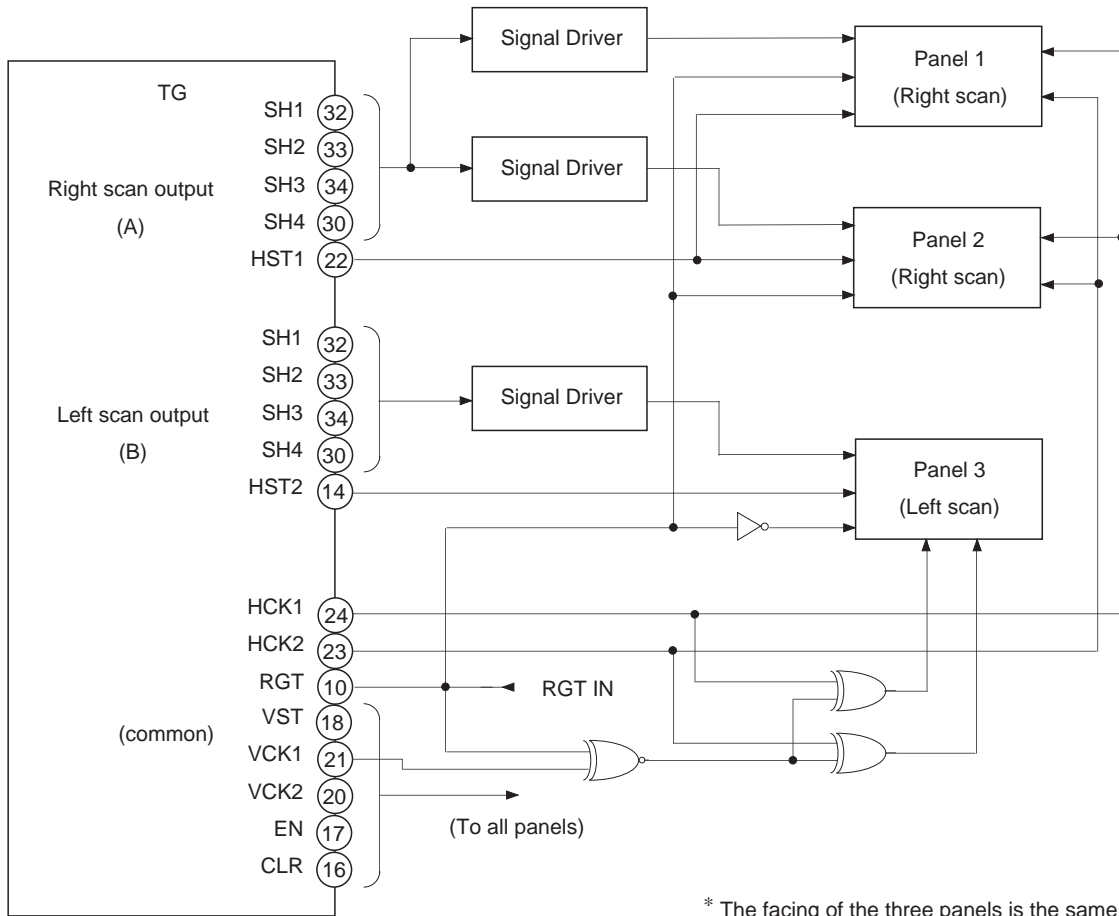
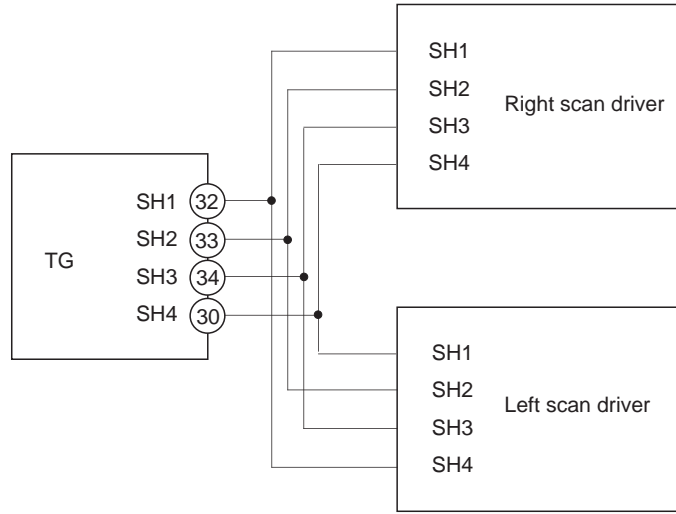

* The facing of the three panels is the same.

SH Pulse and HCK Phase Relationship

The phase relationship between the SH pulse and HCK changes according to switching between right scan (Normal scan) and left scan (Reverse scan).

In the present timing, SH3 is the re-sampling pulse.

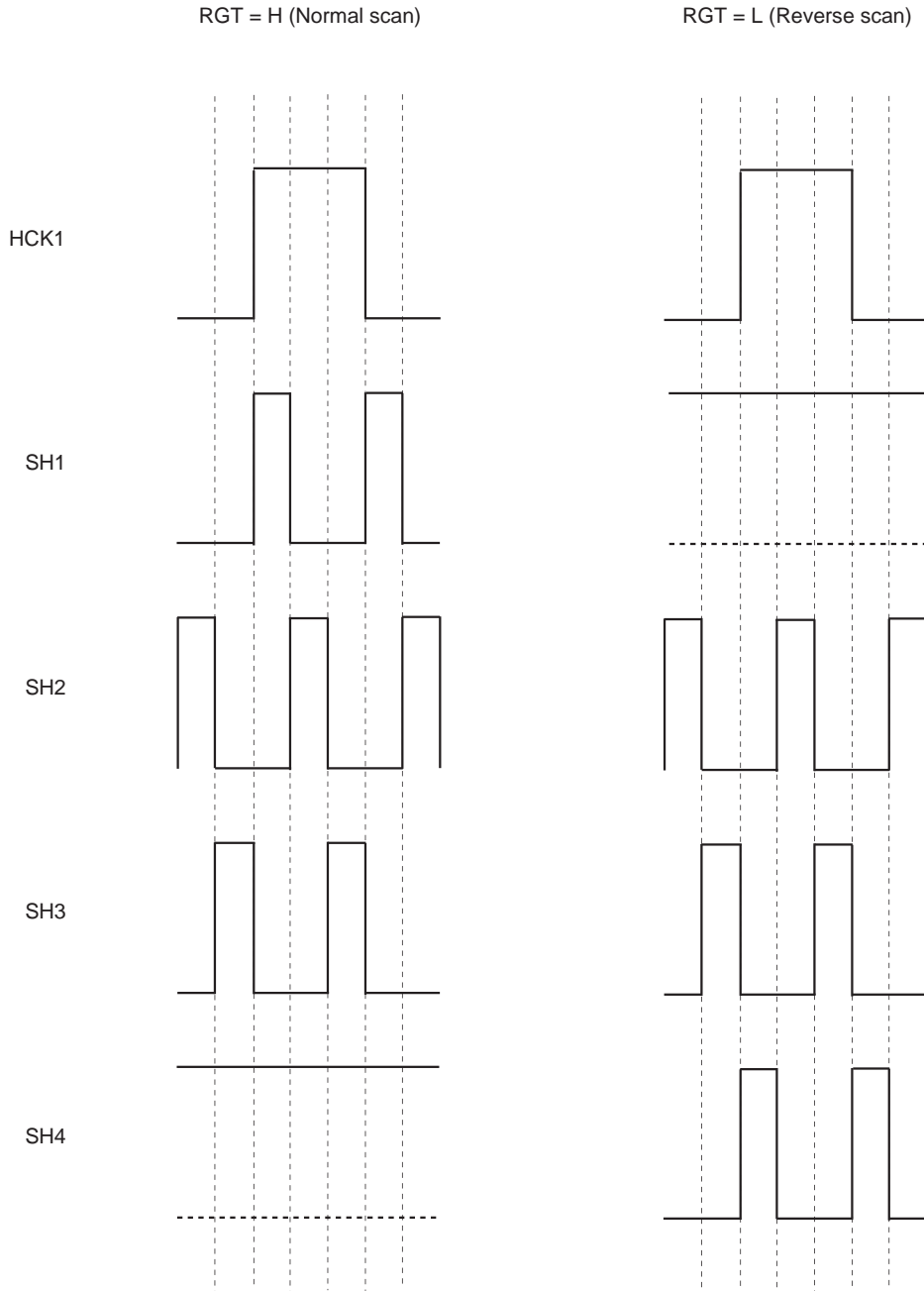

WIDE Mode

Setting the WIDE pin (Pin 4) to H, shifts the unit to WIDE mode. In this mode, the aspect ratio is converted through pulse eliminator processing, allowing 16:9 quasi-WIDE display.

During WIDE mode, vertical pulse eliminator scanning of 1/4 for NTSC and 1/2 and 1/4 for PAL, are performed, and the video signal is compressed to achieve a 16:9 aspect ratio. In addition, in areas outside the display area, black is displayed by performing high-speed scanning. The timing during high-speed scanning is a 2H cycle pulse consisting of normal drive (1H) and quadruple-speed drive (1H) and black signals are written in 28 and 27 lines, respectively of the upper and lower side of this display area. During this time, FRP is changed to a 4H cycle, HST to a 2H cycle, and EN and CLR are not output.

In addition, the SBLK output, which is the black signal generation timing pulse, becomes H.

(For example, black display in the panel is permitted by connecting the black signal output SBLK to the external RGB input pin of the CXA1785R/AR.)

Refer to the attached sheets for detailed timing.

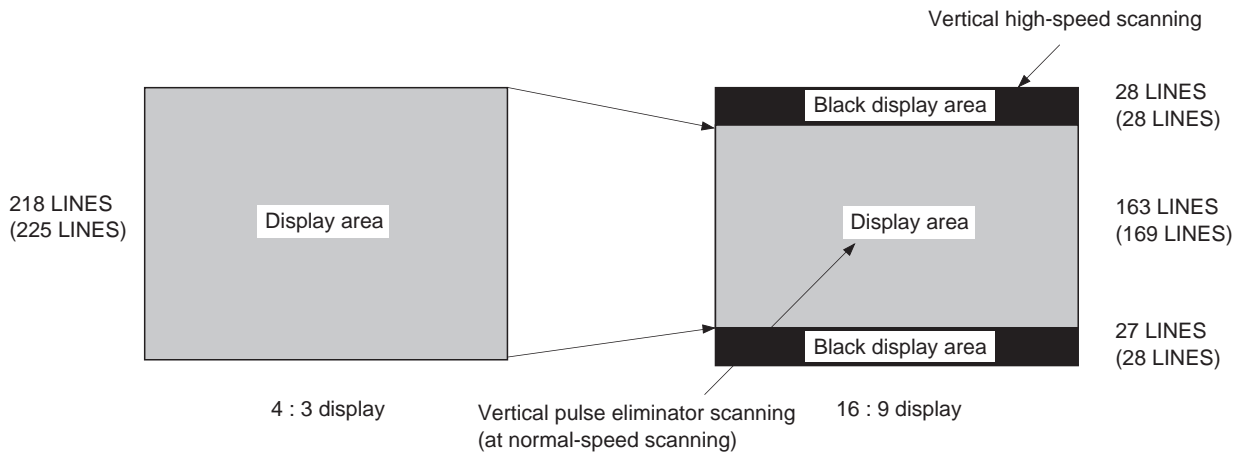

* Numbers in parentheses are for the LCX009AK/AKB.
All other numbers are for the LCX005BK/BKB.

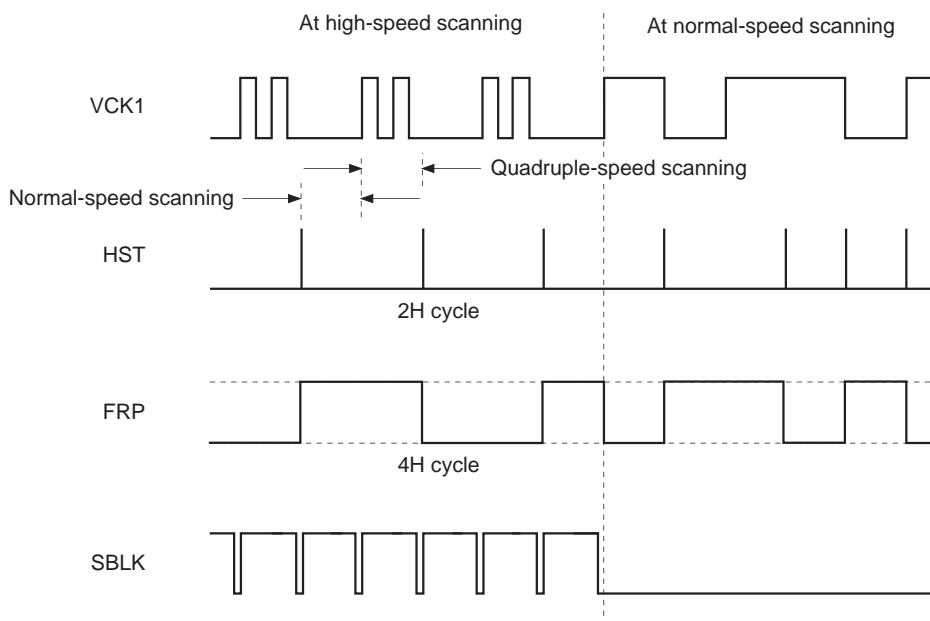

LCX005BK/BKB Horizontal Direction Timing Chart
NTSC/PAL

HP1/2/3/4: LLLH
 RGT: H (Normal scan)

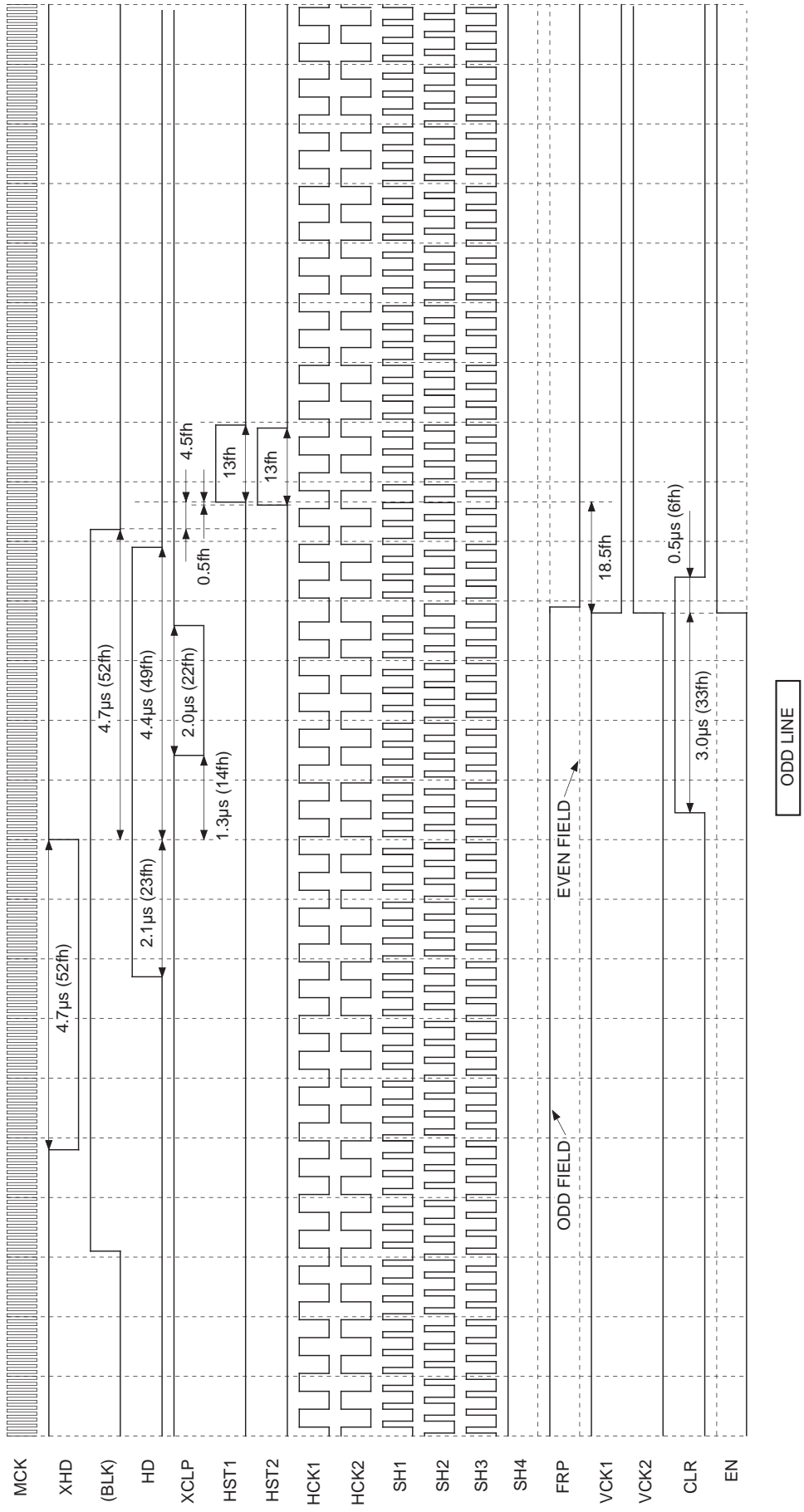

Note) The third row of the timing chart "BLK" is a pulse indicated as a reference and is not a pulse output from pins.
 FRP polarity is not specified for each line and field.

LCX005BK/BK Horizontal Direction Timing Chart
NTSC/PAL

HP1/2/3/4: LLLH
 RGT: H (Normal scan)

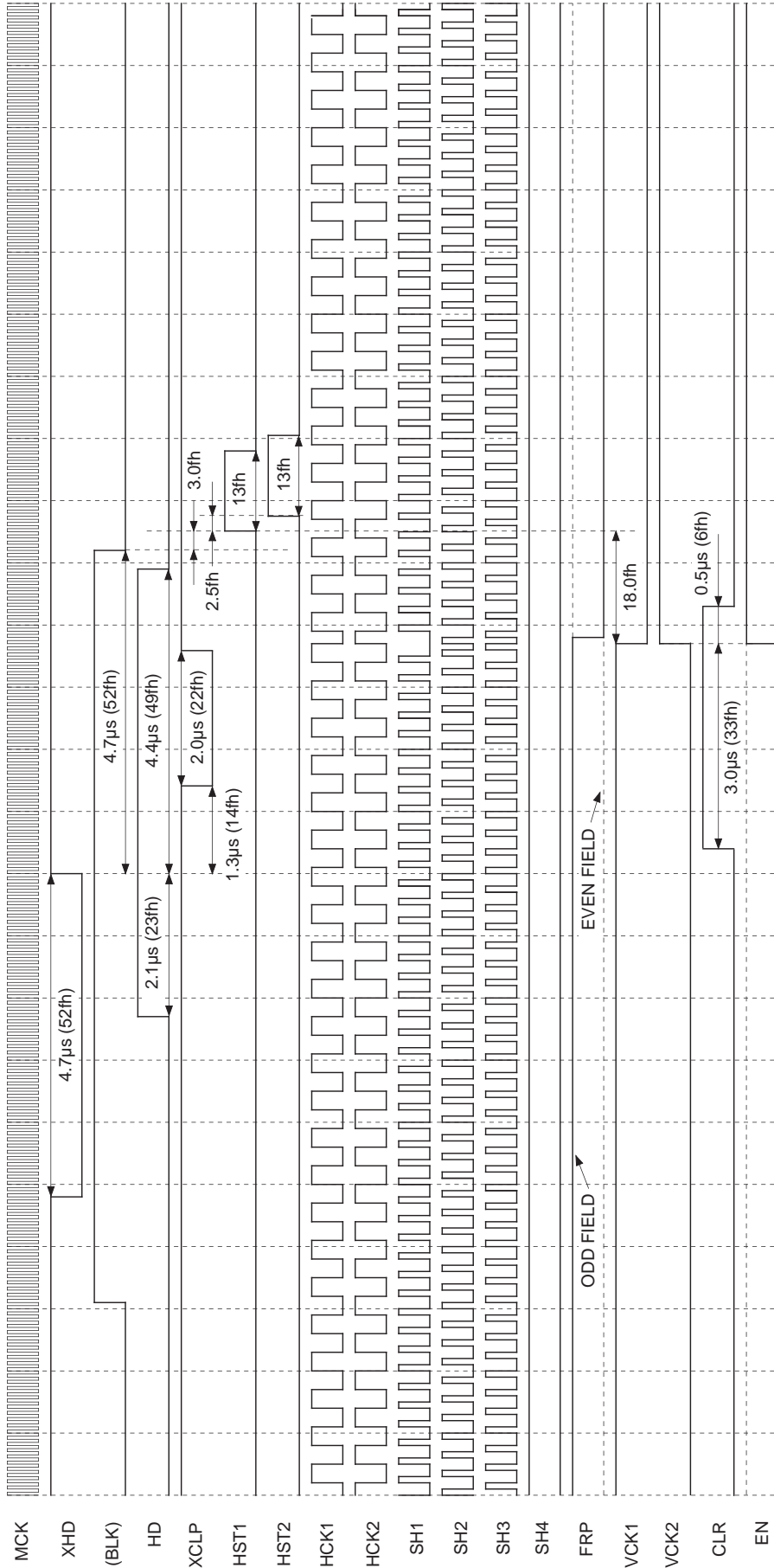

Note) The third row of the timing chart "BLK" is a pulse indicated as a reference and is not a pulse output from pins.
 FRP polarity is not specified for each line and field.

LCX005BK/BKB Horizontal Direction Timing Chart
NTSC/PAL

HP1/2/3/4: LLLH
 RGT: L (Reverse scan)

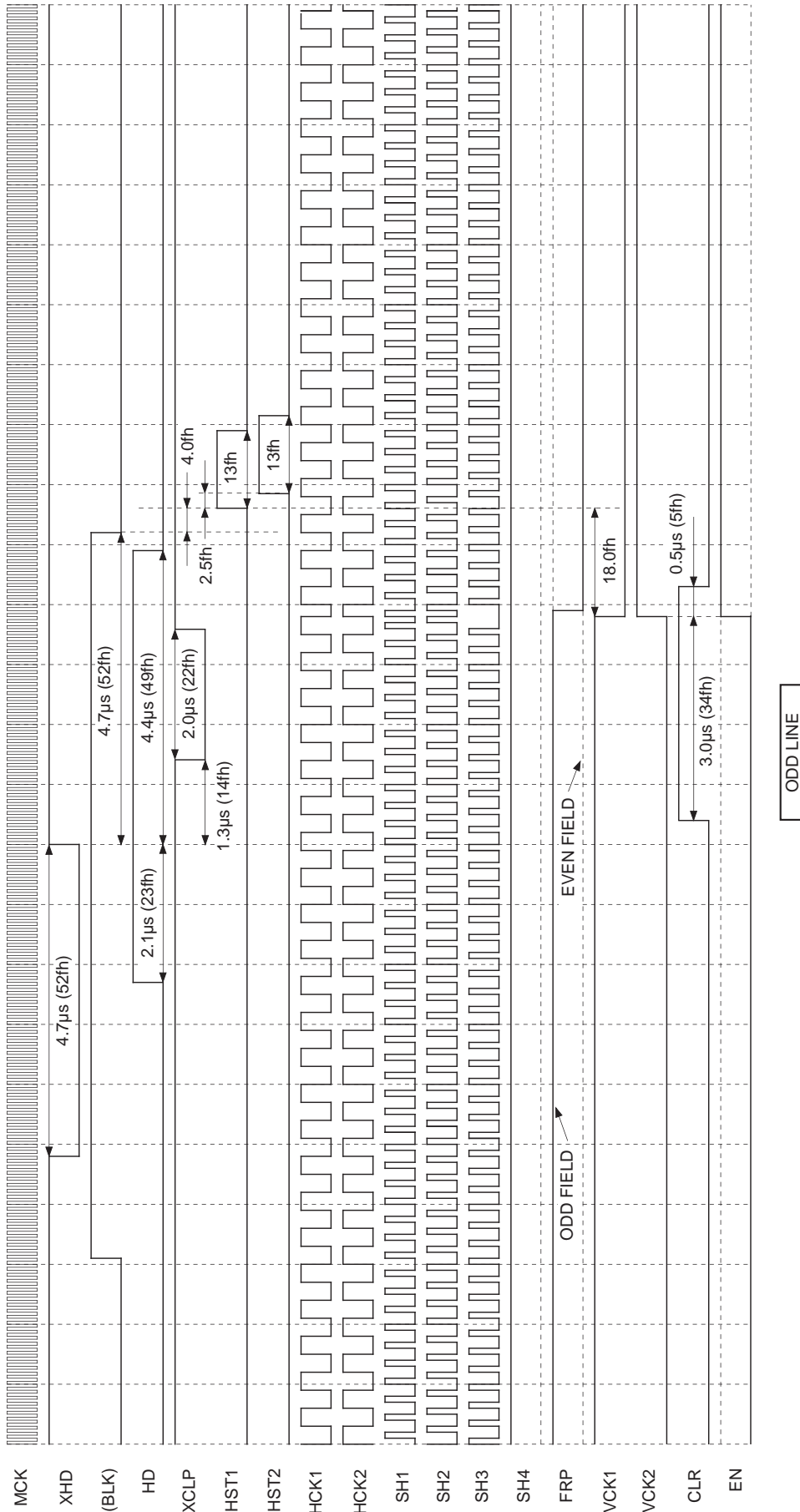

Note) The third row of the timing chart "BLK" is a pulse indicated as a reference and is not a pulse output from pins.
 FRP polarity is not specified for each line and field.

LCX005BK/BKB Horizontal Direction Timing Chart
NTSC/PAL

HP1/2/3/4: LLLH
 RGT: L (Reverse scan)

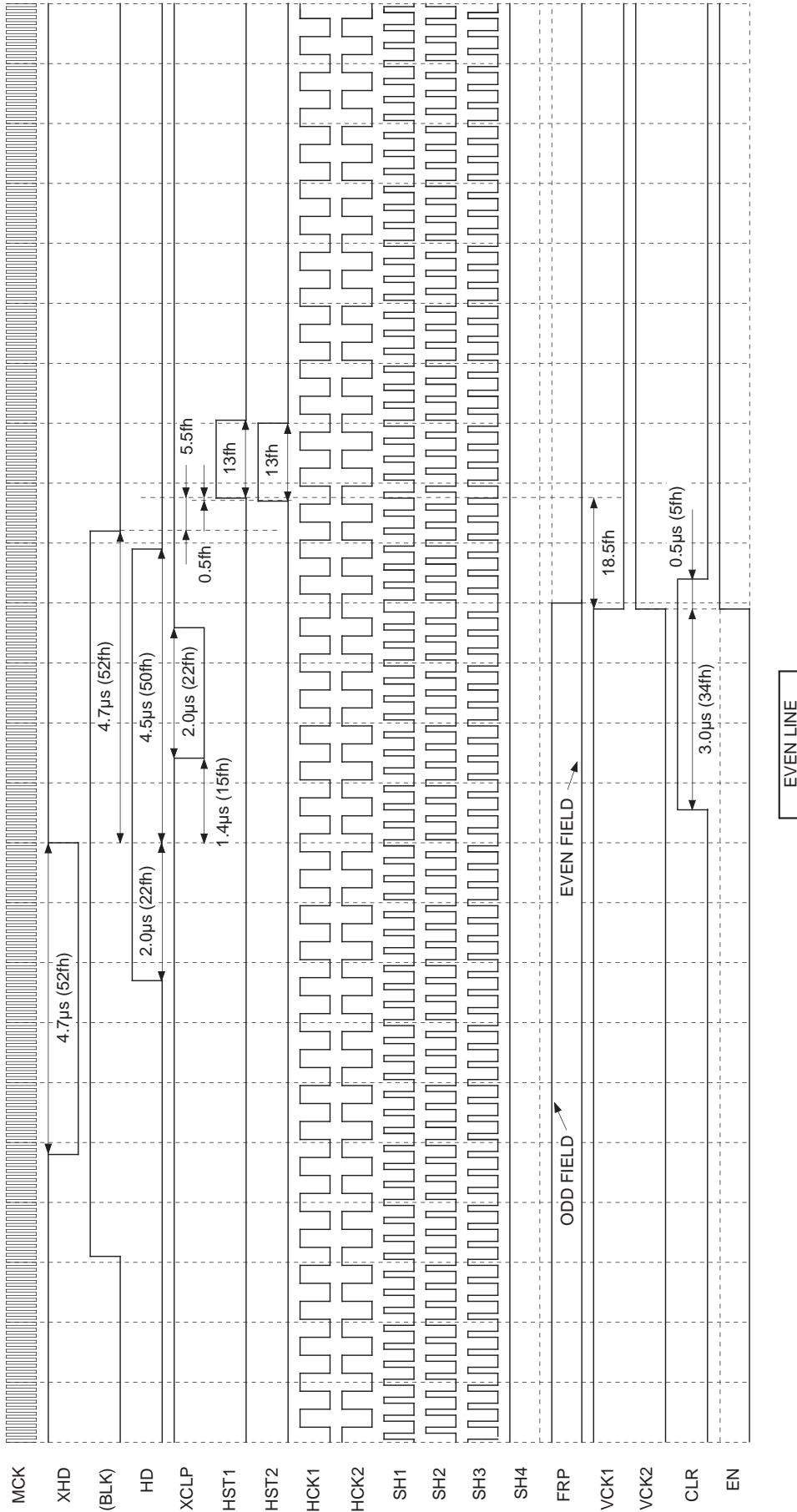

Note) The third row of the timing chart "BLK" is a pulse indicated as a reference and is not a pulse output from pins.
 FRP polarity is not specified for each line and field.

**LCX009AK/AKB Horizontal Direction Timing Chart
NTSC/PAL**

HP1/2/3/4: LLLH
RGT: H (Normal scan)

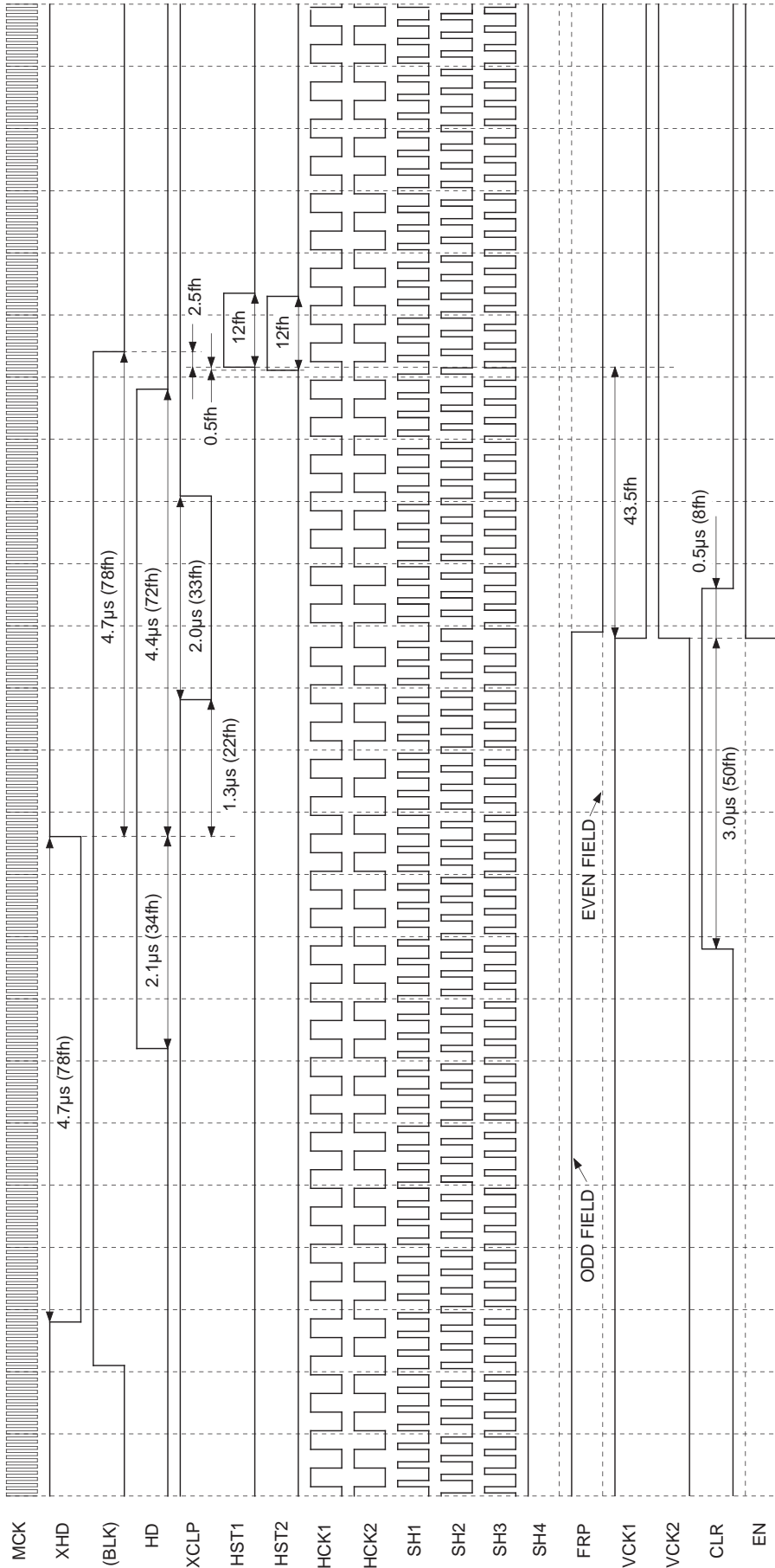

ODD LINE

Note) The third row of the timing chart "BLK" is a pulse indicated as a reference and is not a pulse output from pins.
FRP polarity is not specified for each line and field.

LCX009AK/KB Horizontal Direction Timing Chart
NTSC/PAL

HP1/2/3/4: LLLH
 RGT: H (Normal scan)

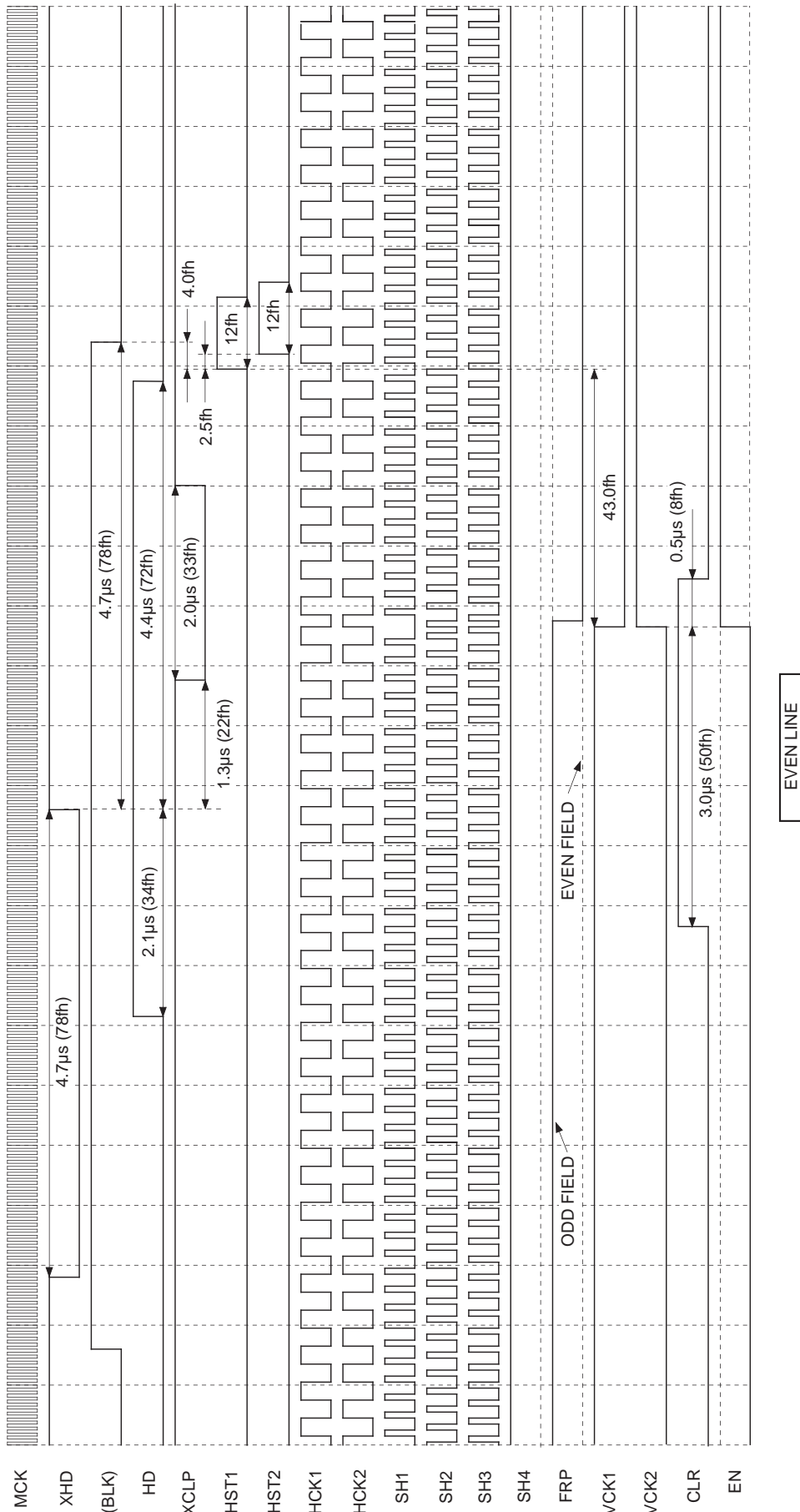

Note) The third row of the timing chart "BLK" is a pulse indicated as a reference and is not a pulse output from pins.
 FRP polarity is not specified for each line and field.

LCX009AK/AKB Horizontal Direction Timing Chart
NTSC/PAL

HP1/2/3/4: LLLH
 RGT: L (Reverse scan)

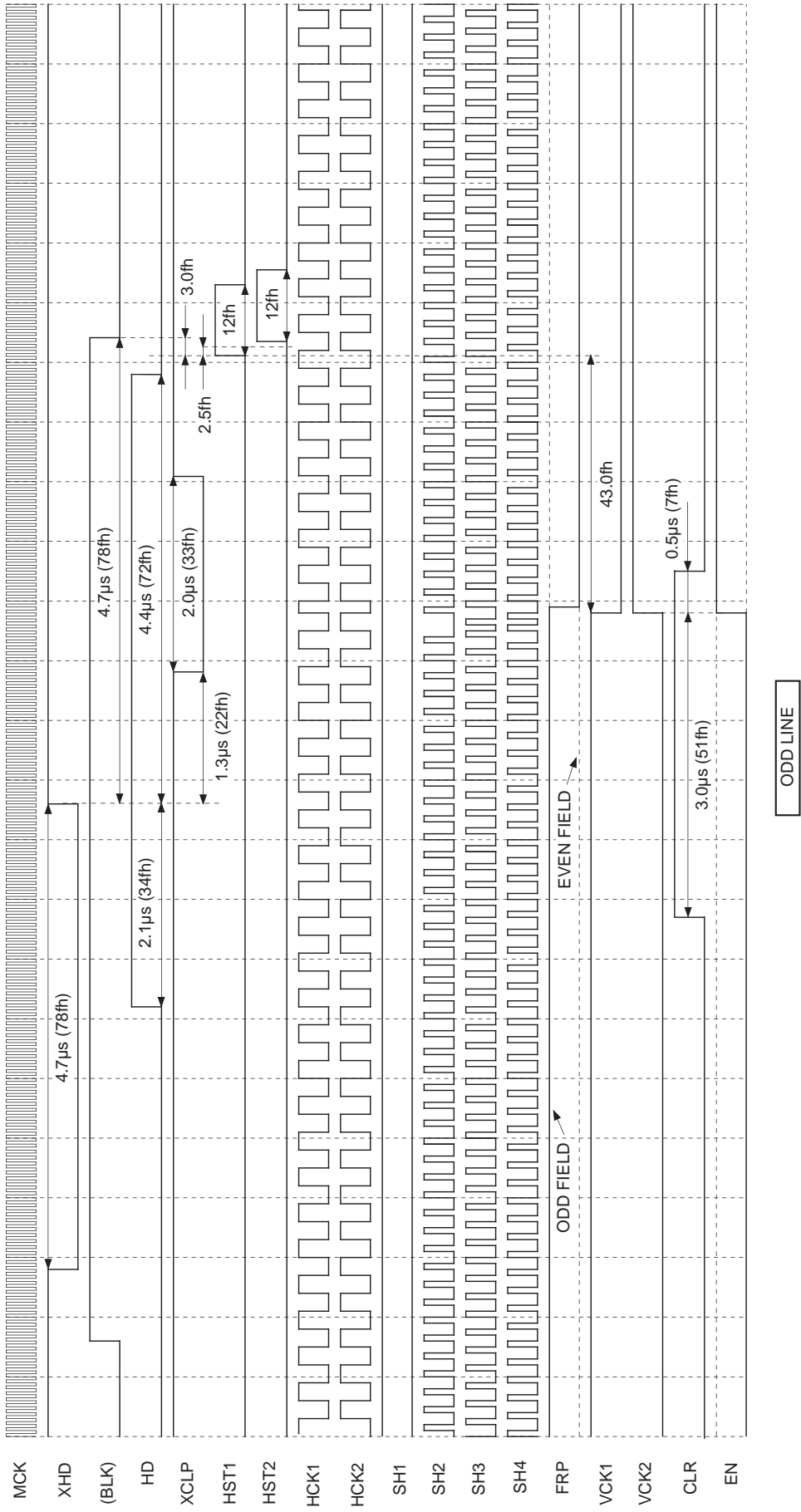

Note) The third row of the timing chart "BLK" is a pulse indicated as a reference and is not a pulse output from pins.
 FRP polarity is not specified for each line and field.

LCX009AK/KB Horizontal Direction Timing Chart
NTSC/PAL

HP1/2/3/4: LLLH
 RGT: L (Reverse scan)

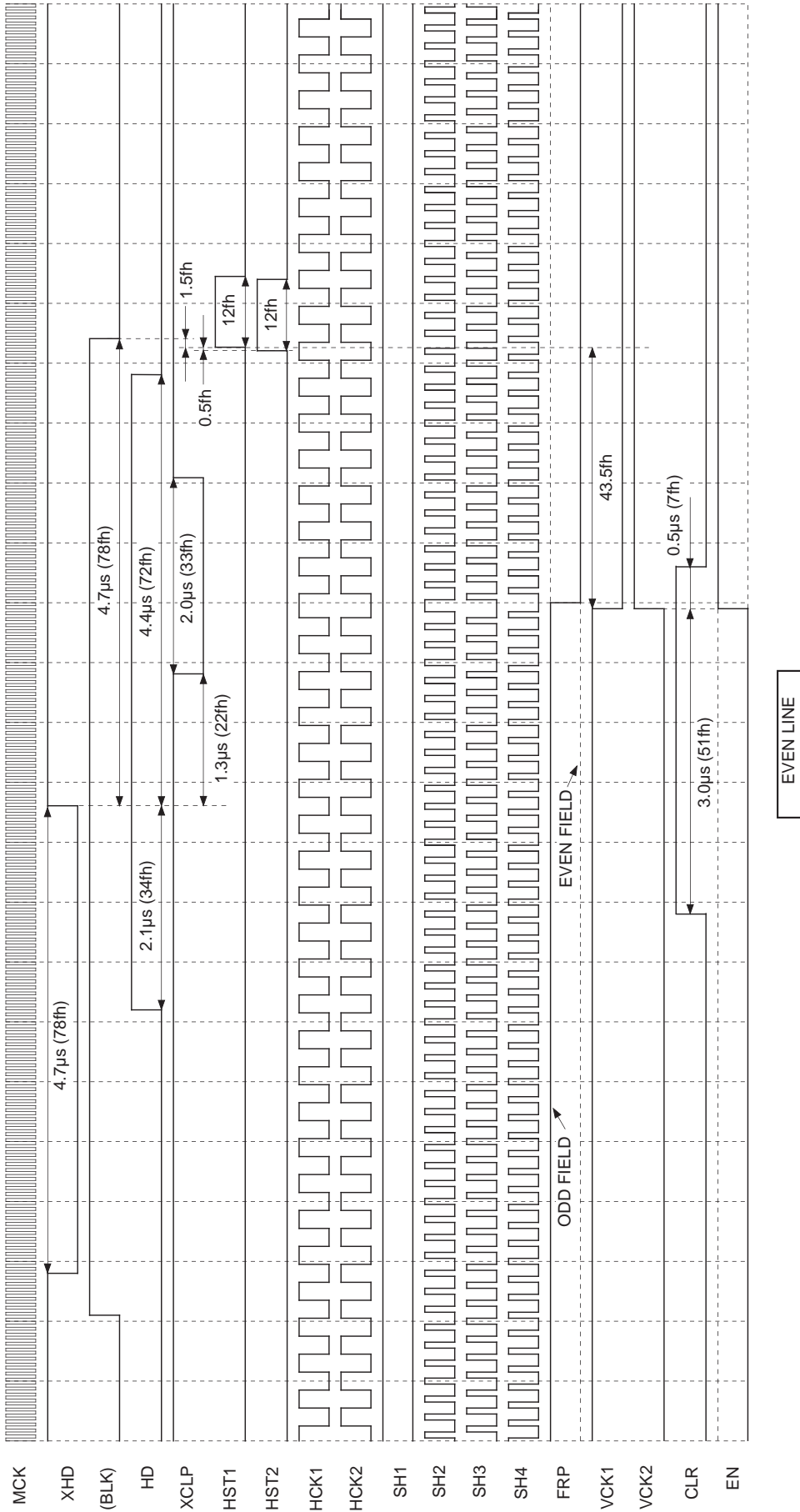

Note) The third row of the timing chart "BLK" is a pulse indicated as a reference and is not a pulse output from pins.
 FRP polarity is not specified for each line and field.

**LCX005BK/BKB Vertical Direction Timing Chart
NTSC**

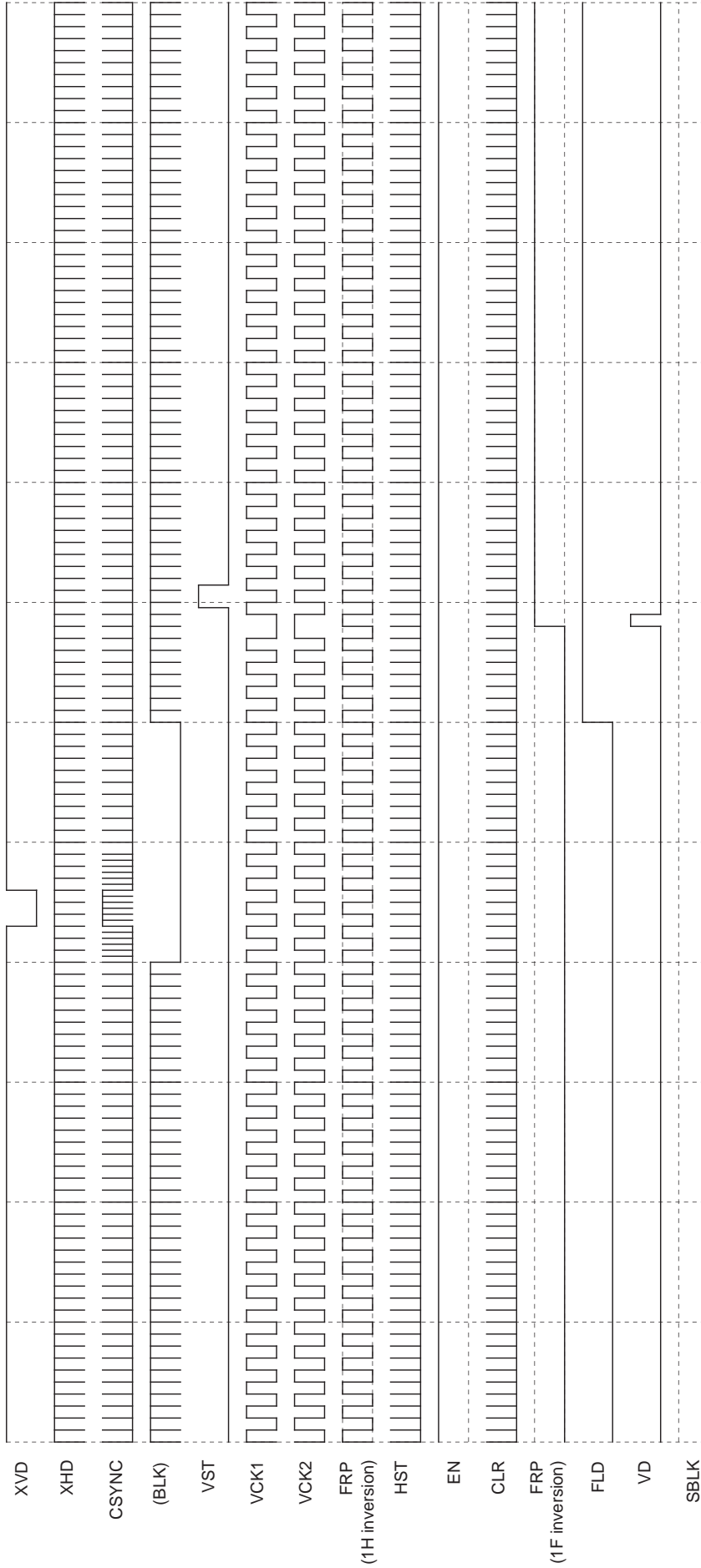

Note) The fourth row of the timing chart "BLK" is a pulse indicated as a reference and is not a pulse output from pins.
FRP polarity is not specified for each line and field.

LCX005BK/BKB Vertical Direction Timing Chart
NTSC

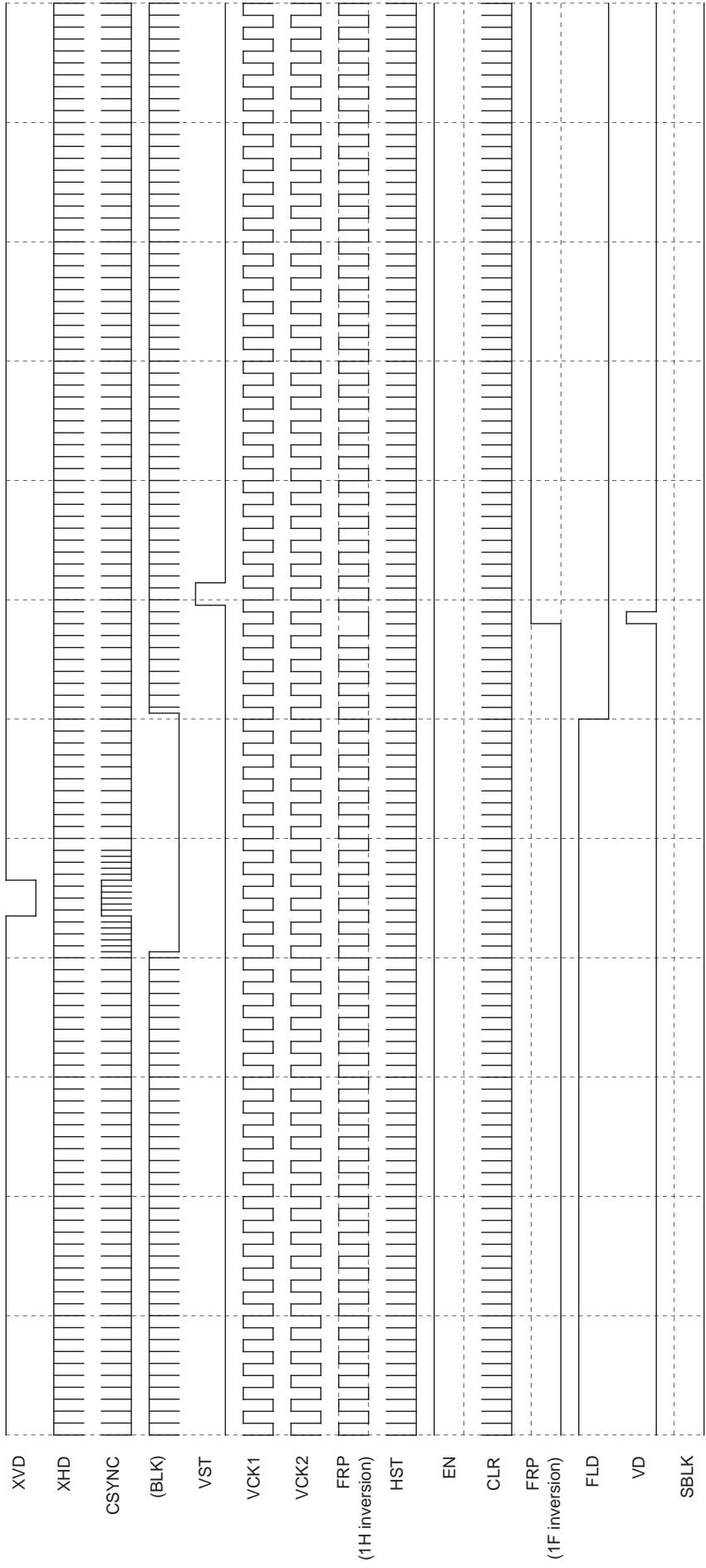

Note) The fourth row of the timing chart "BLK" is a pulse indicated as a reference and is not a pulse output from pins.
 FRP polarity is not specified for each line and field.

LCX005BK/BKB Vertical Direction Timing Chart
PAL

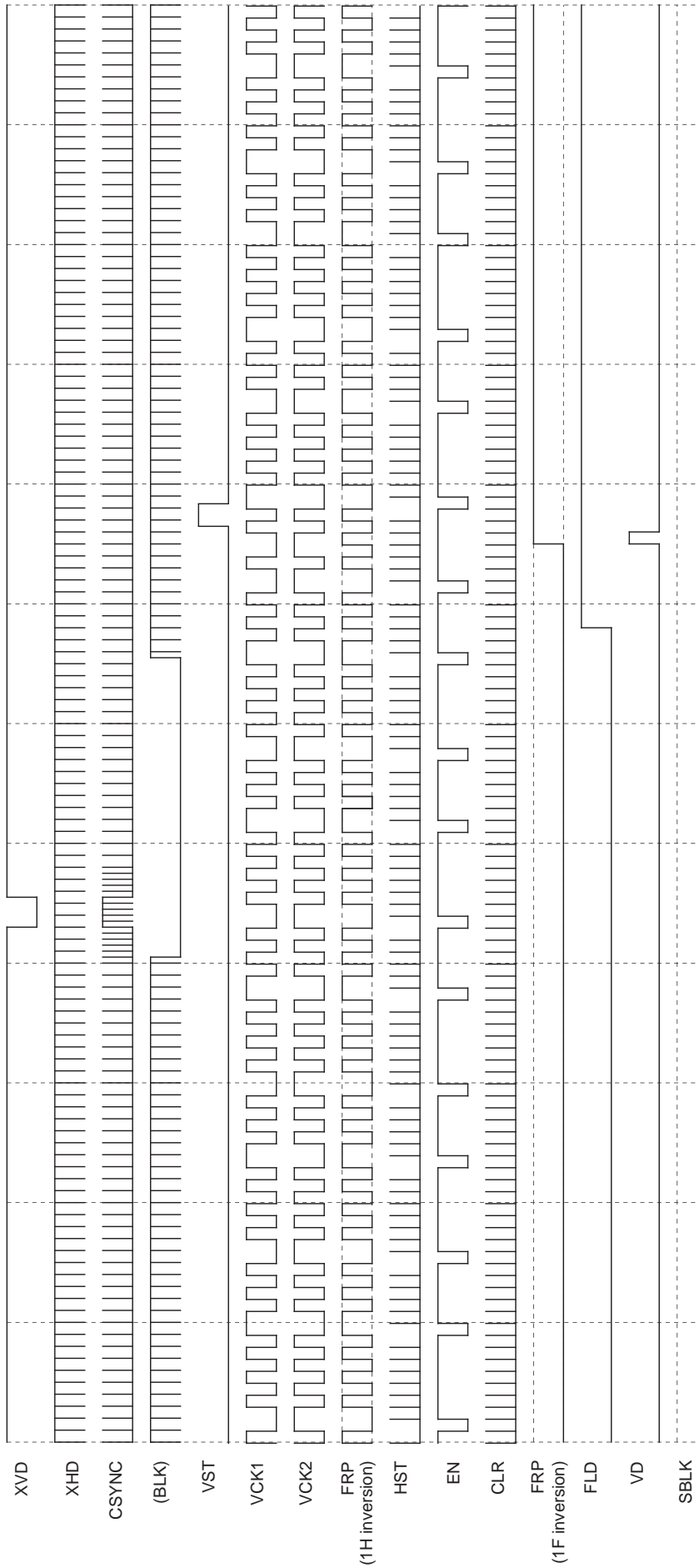

Note) The fourth row of the timing chart "BLK" is a pulse indicated as a reference and is not a pulse output from pins.
 FRP polarity is not specified for each line and field.

LCX005BK/BKB Vertical Direction Timing Chart
PAL

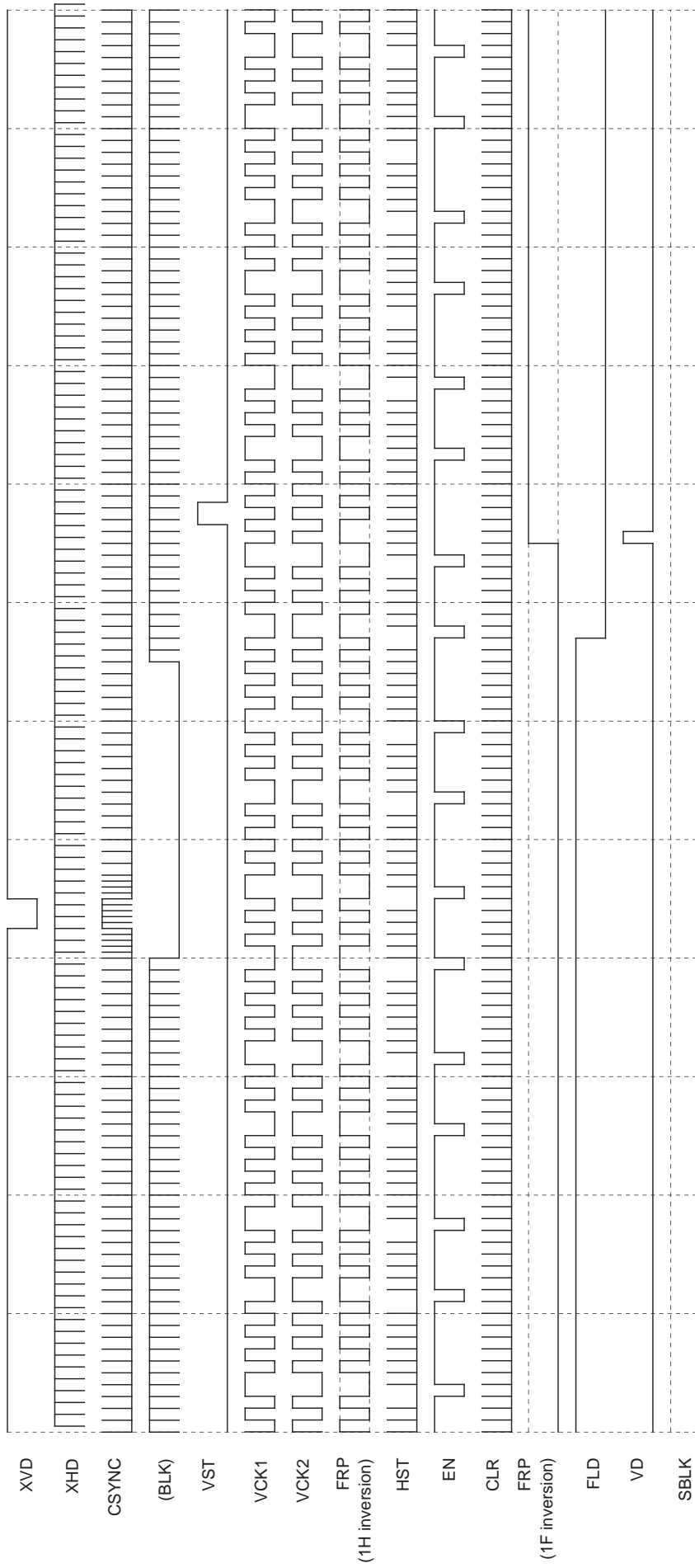

EVEN FIELD

Note) The fourth row of the timing chart "BLK" is a pulse indicated as a reference and is not a pulse output from pins.
 FRP polarity is not specified for each line and field.

LCX009AK/AKB Vertical Direction Timing Chart
NTSC

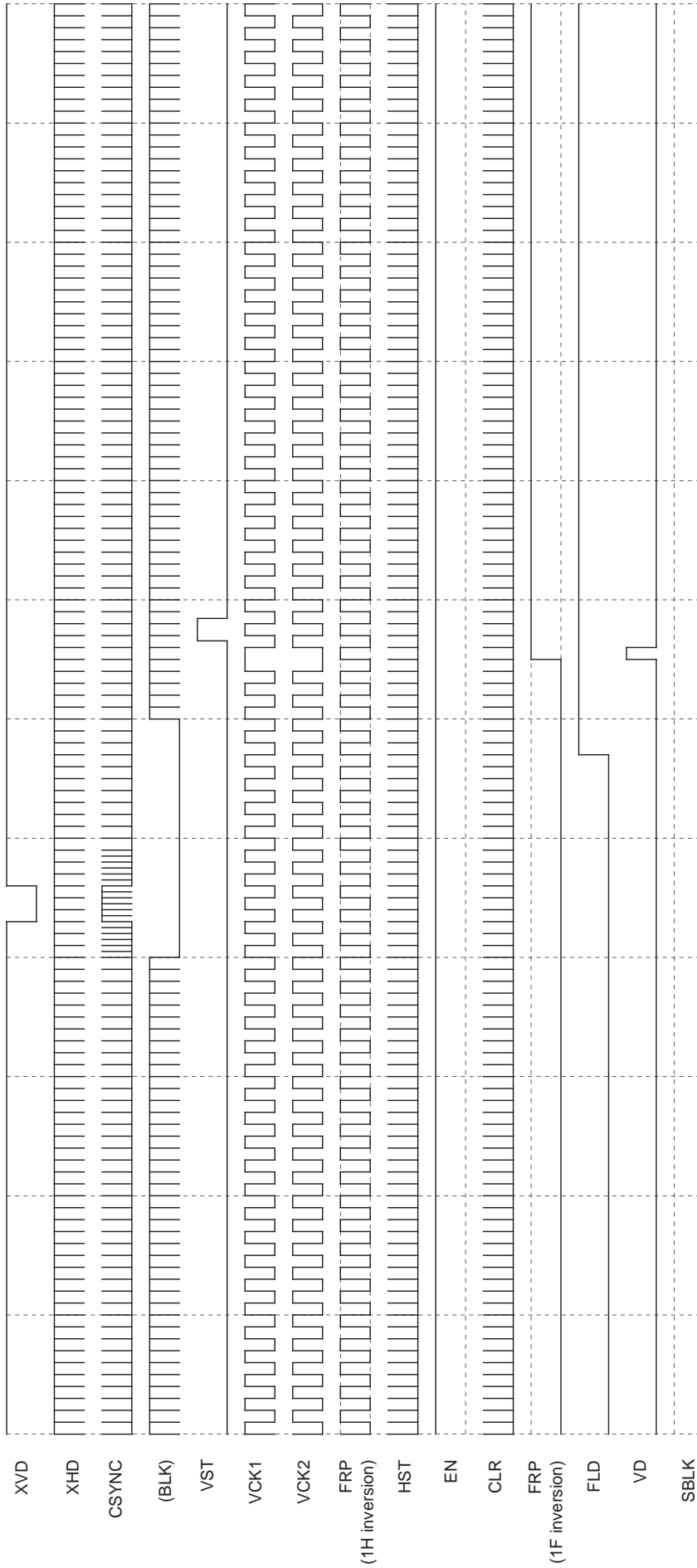

ODD FIELD

Note) The fourth row of the timing chart "BLK" is a pulse indicated as a reference and is not a pulse output from pins.
 FRP polarity is not specified for each line and field.

LCX009AK/AKB Vertical Direction Timing Chart
NTSC

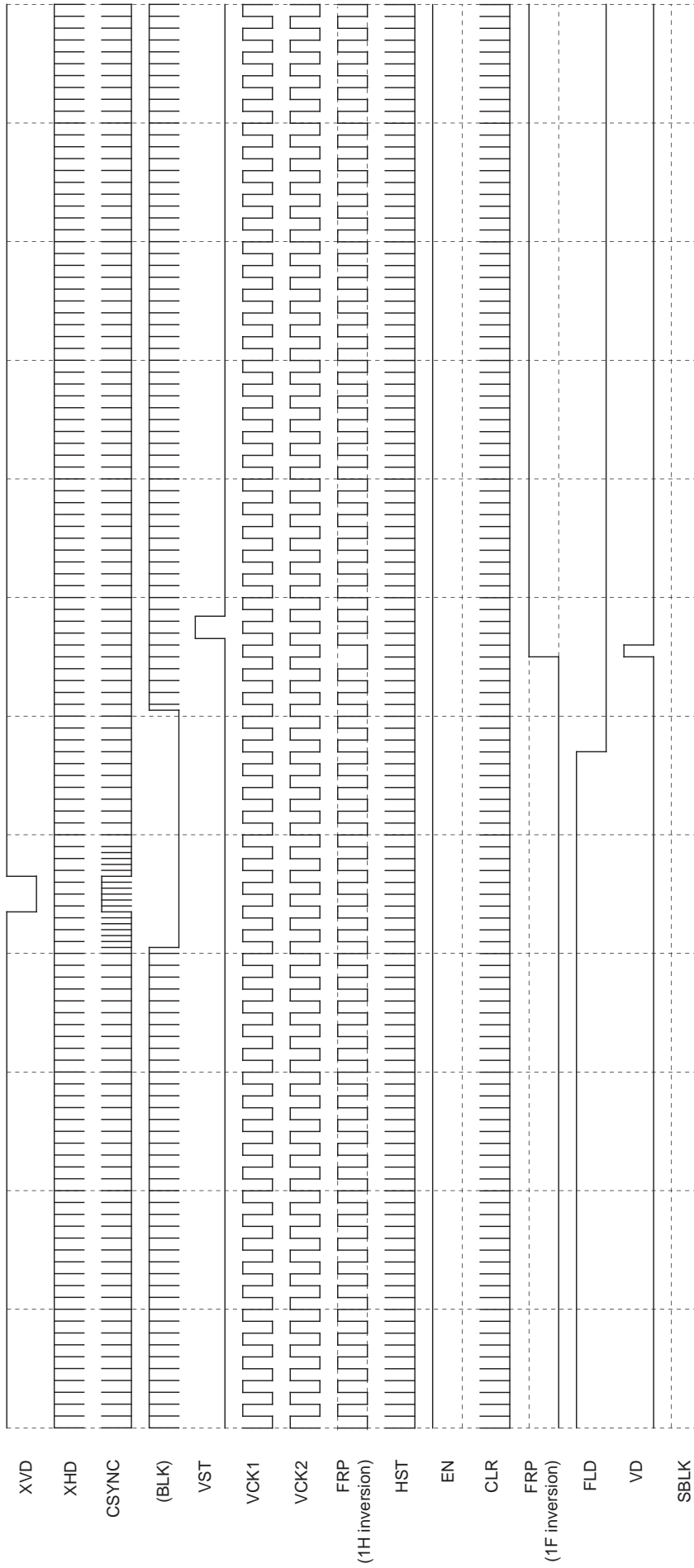

Note) The fourth row of the timing chart "BLK" is a pulse indicated as a reference and is not a pulse output from pins.
 FRP polarity is not specified for each line and field.

LCX009AK/AKB Vertical Direction Timing Chart
PAL

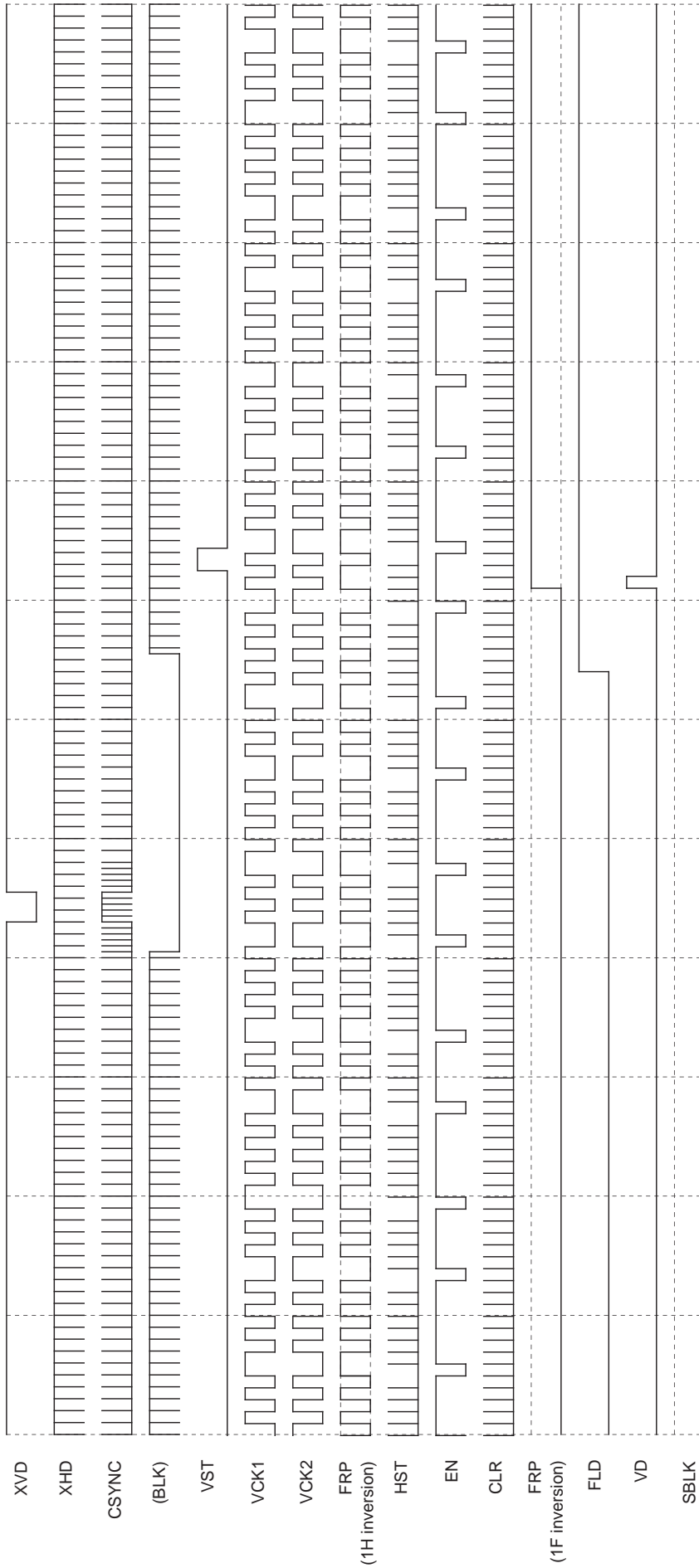

ODD FIELD

Note) The fourth row of the timing chart "BLK" is a pulse indicated as a reference and is not a pulse output from pins.
FRP polarity is not specified for each line and field.

LCX009AK/AKB Vertical Direction Timing Chart
PAL

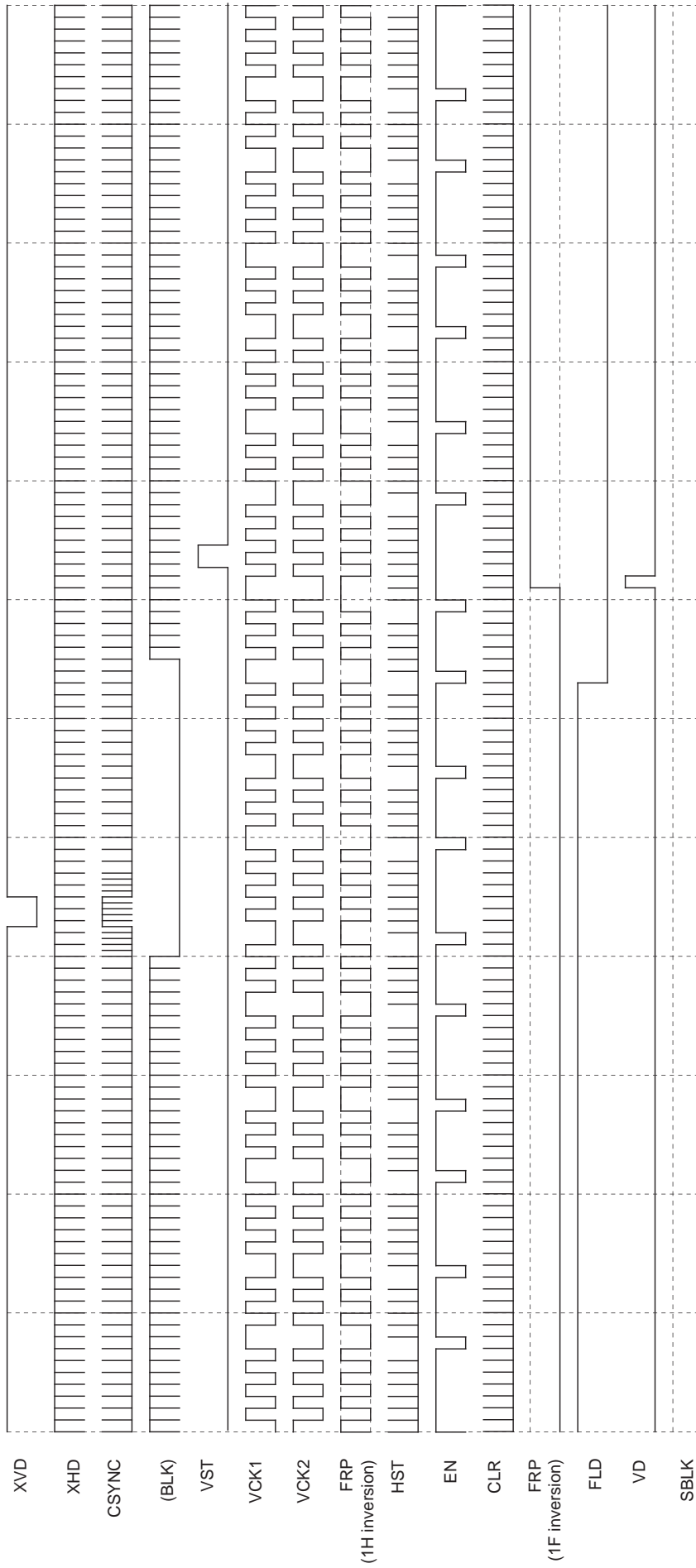

EVEN FIELD

Note) The fourth row of the timing chart "BLK" is a pulse indicated as a reference and is not a pulse output from pins.
 FRP polarity is not specified for each line and field.

LCX005BK/BKB WIDE Vertical Direction Timing Chart
NTSC

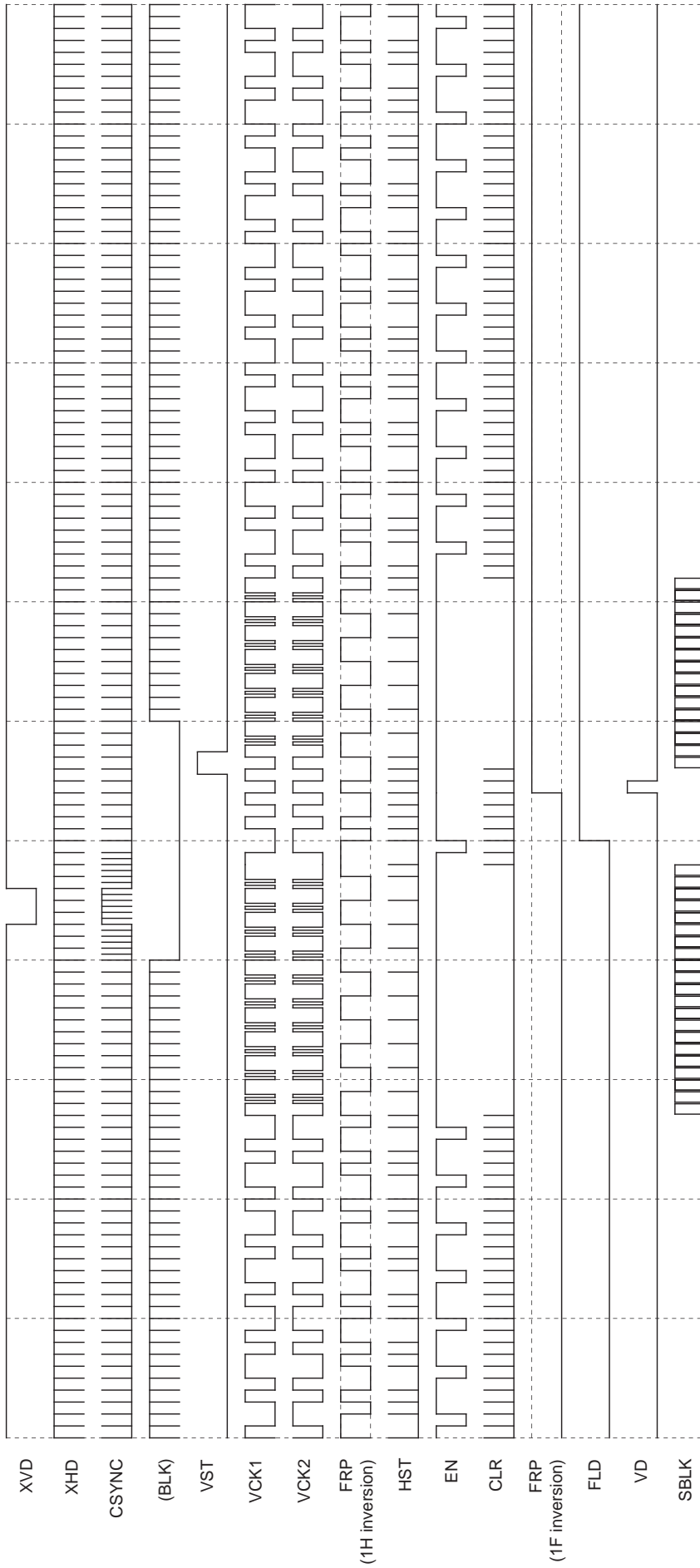

Note) The fourth row of the timing chart "BLK" is a pulse indicated as a reference and is not a pulse output from pins.
FRP polarity is not specified for each line and field.

LCX005BK/BKB WIDE Vertical Direction Timing Chart
NTSC

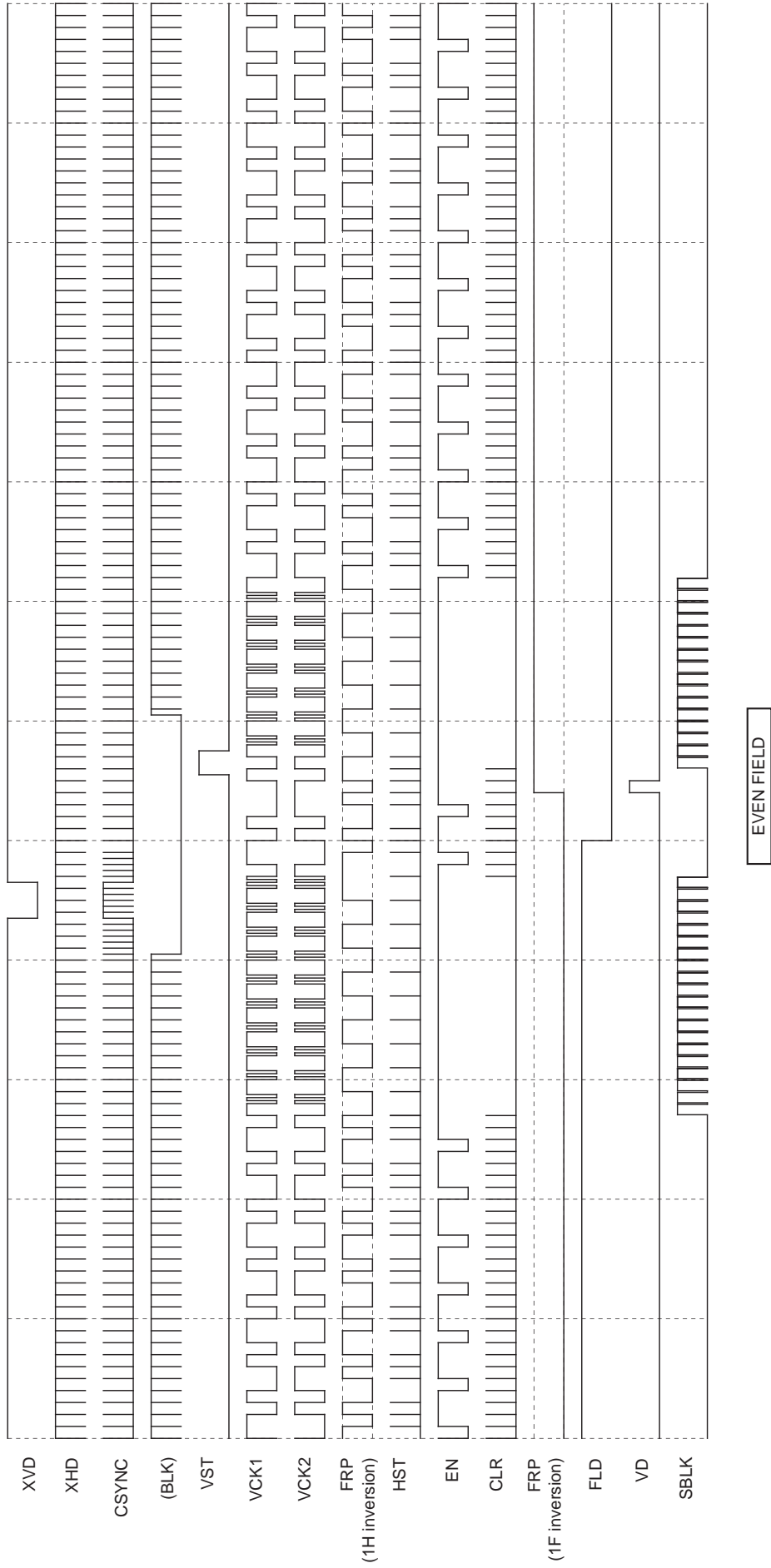

Note) The fourth row of the timing chart "BLK" is a pulse indicated as a reference and is not a pulse output from pins.
FRP polarity is not specified for each line and field.

LCX005BK/BKB WIDE Vertical Direction Timing Chart
PAL

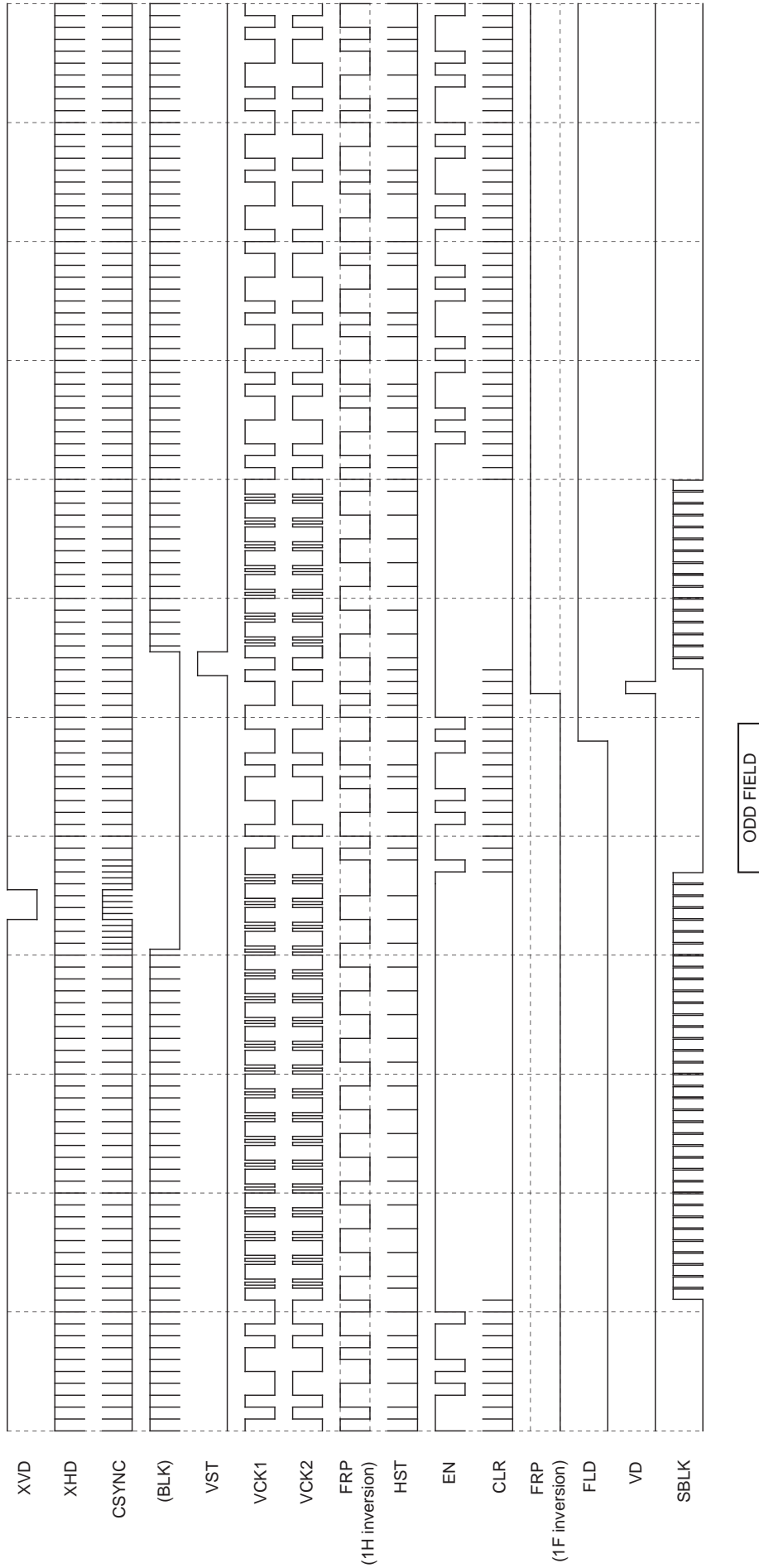

Note) The fourth row of the timing chart "BLK" is a pulse indicated as a reference and is not a pulse output from pins.
 FRP polarity is not specified for each line and field.

LCX005BK/BKB WIDE Vertical Direction Timing Chart
PAL

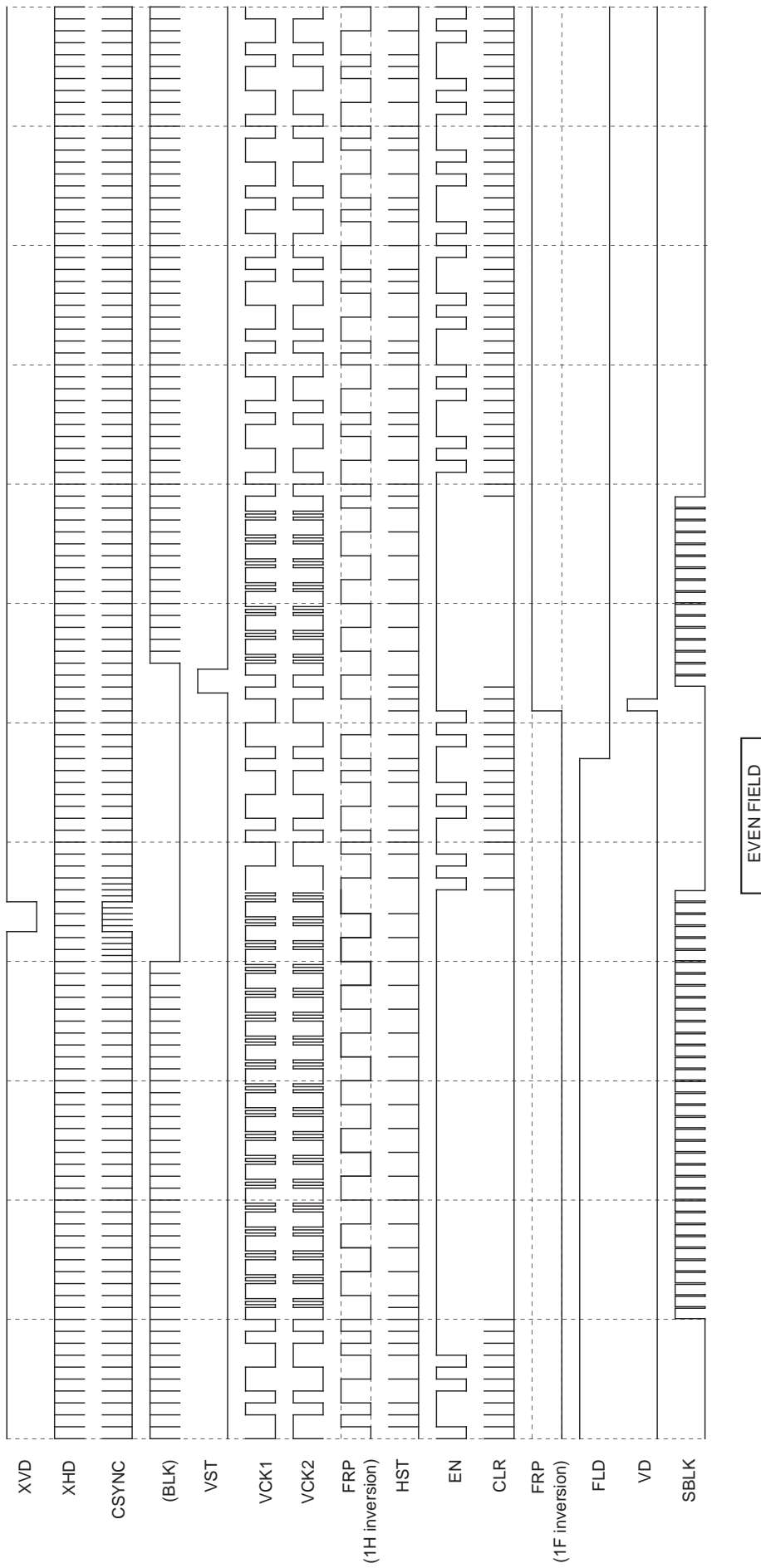

Note) The fourth row of the timing chart "BLK" is a pulse indicated as a reference and is not a pulse output from pins.
 FRP polarity is not specified for each line and field.

LCX009AK/AKB WIDE Vertical Direction Timing Chart
NTSC

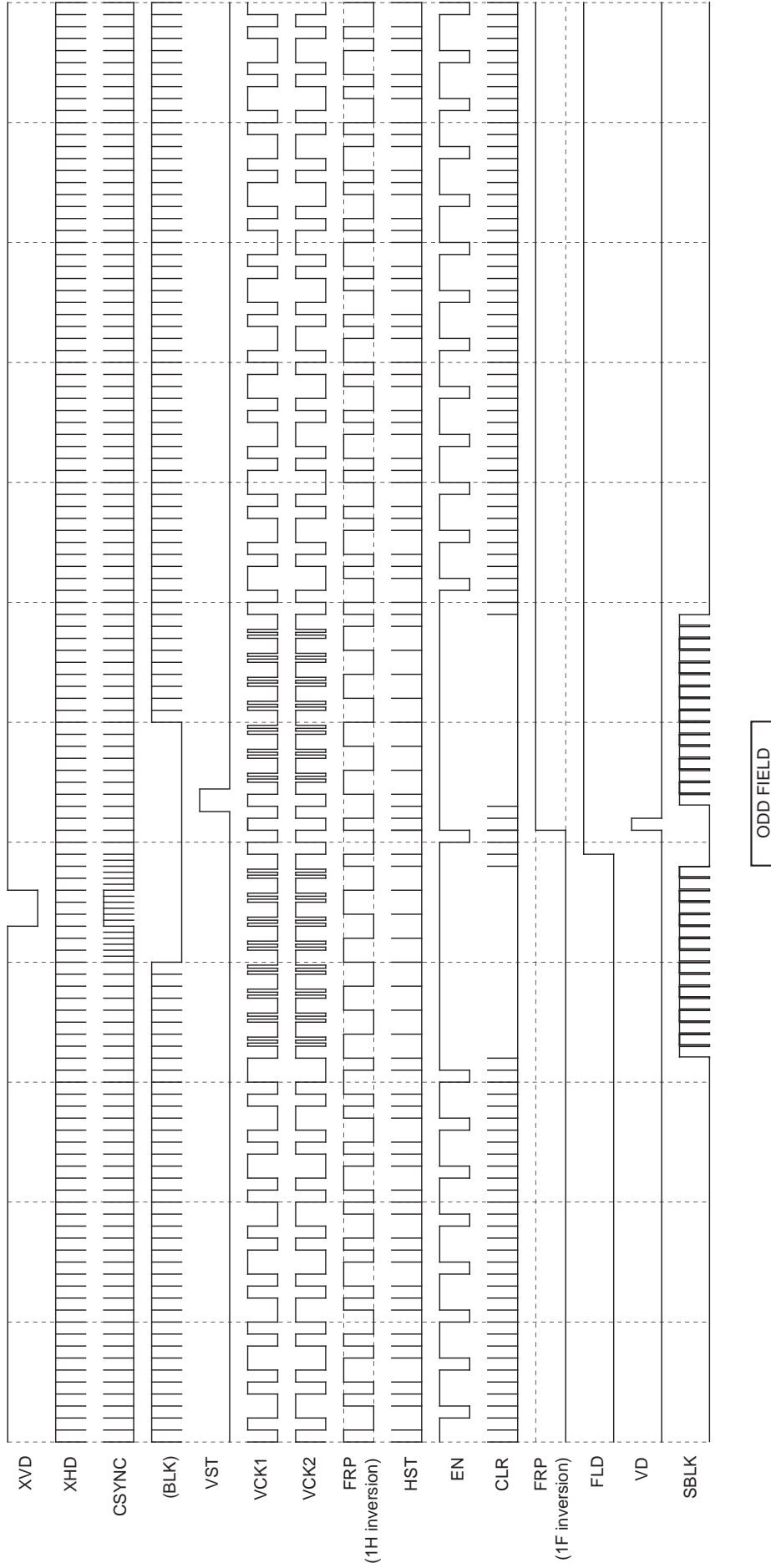

Note) The fourth row of the timing chart "BLK" is a pulse indicated as a reference and is not a pulse output from pins.
FRP polarity is not specified for each line and field.

LCX009AK/AKB WIDE Vertical Direction Timing Chart
NTSC

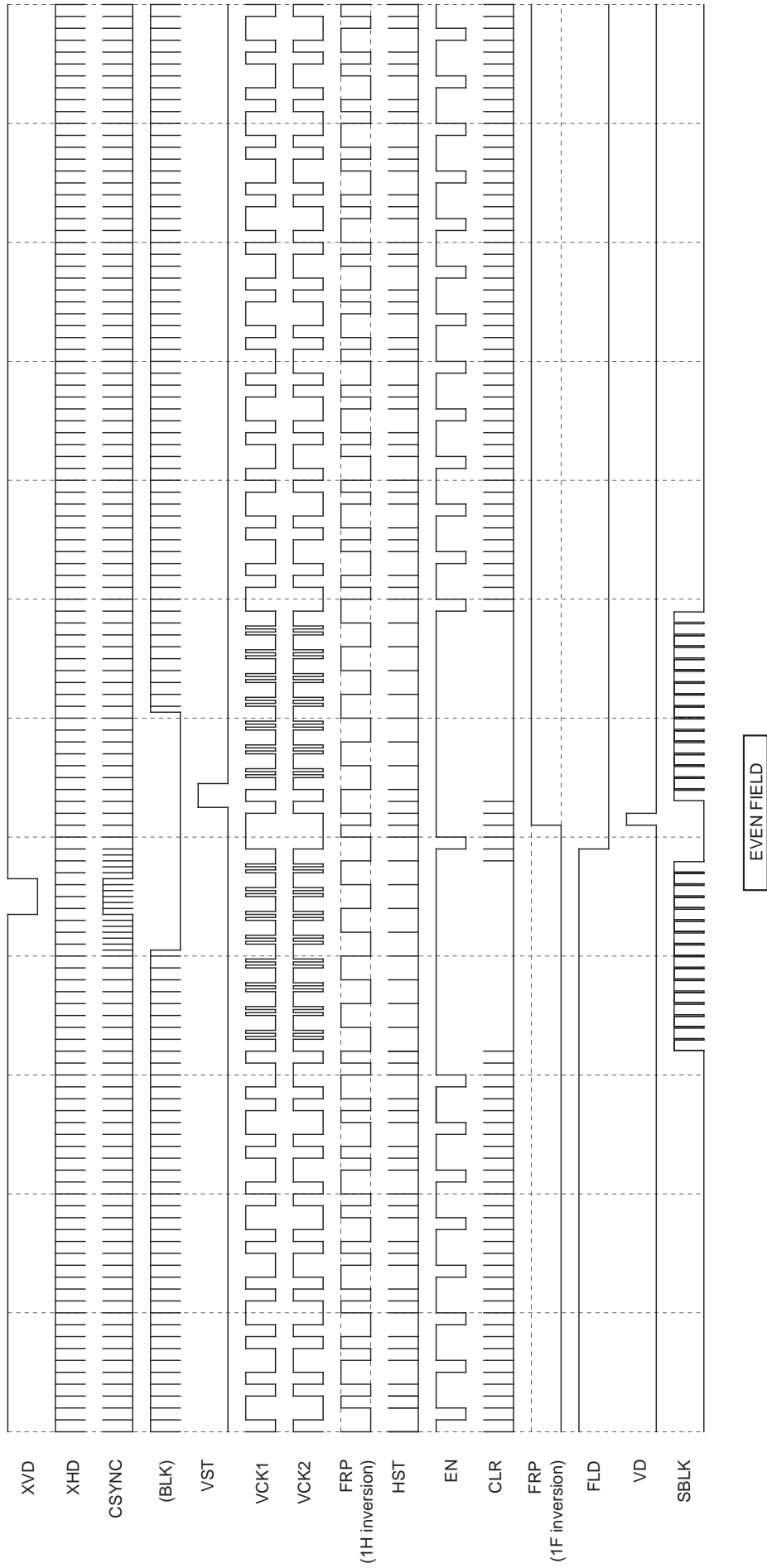

Note) The fourth row of the timing chart "BLK" is a pulse indicated as a reference and is not a pulse output from pins.
 FRP polarity is not specified for each line and field.

LCX009AK/AKB WIDE Vertical Direction Timing Chart
PAL

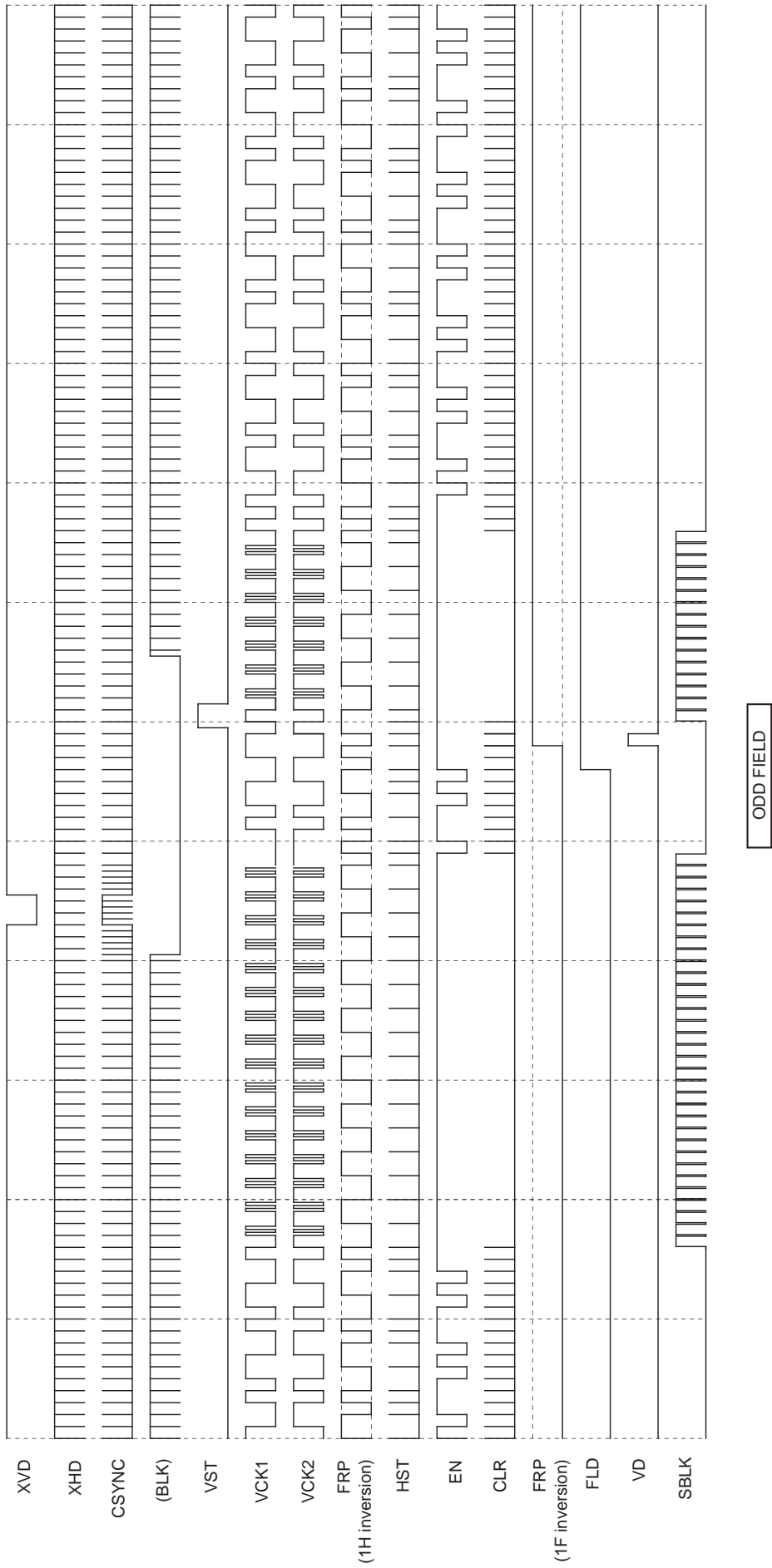

Note) The fourth row of the timing chart "BLK" is a pulse indicated as a reference and is not a pulse output from pins.
 FRP polarity is not specified for each line and field.

LCX009AK/AKB WIDE Vertical Direction Timing Chart
PAL

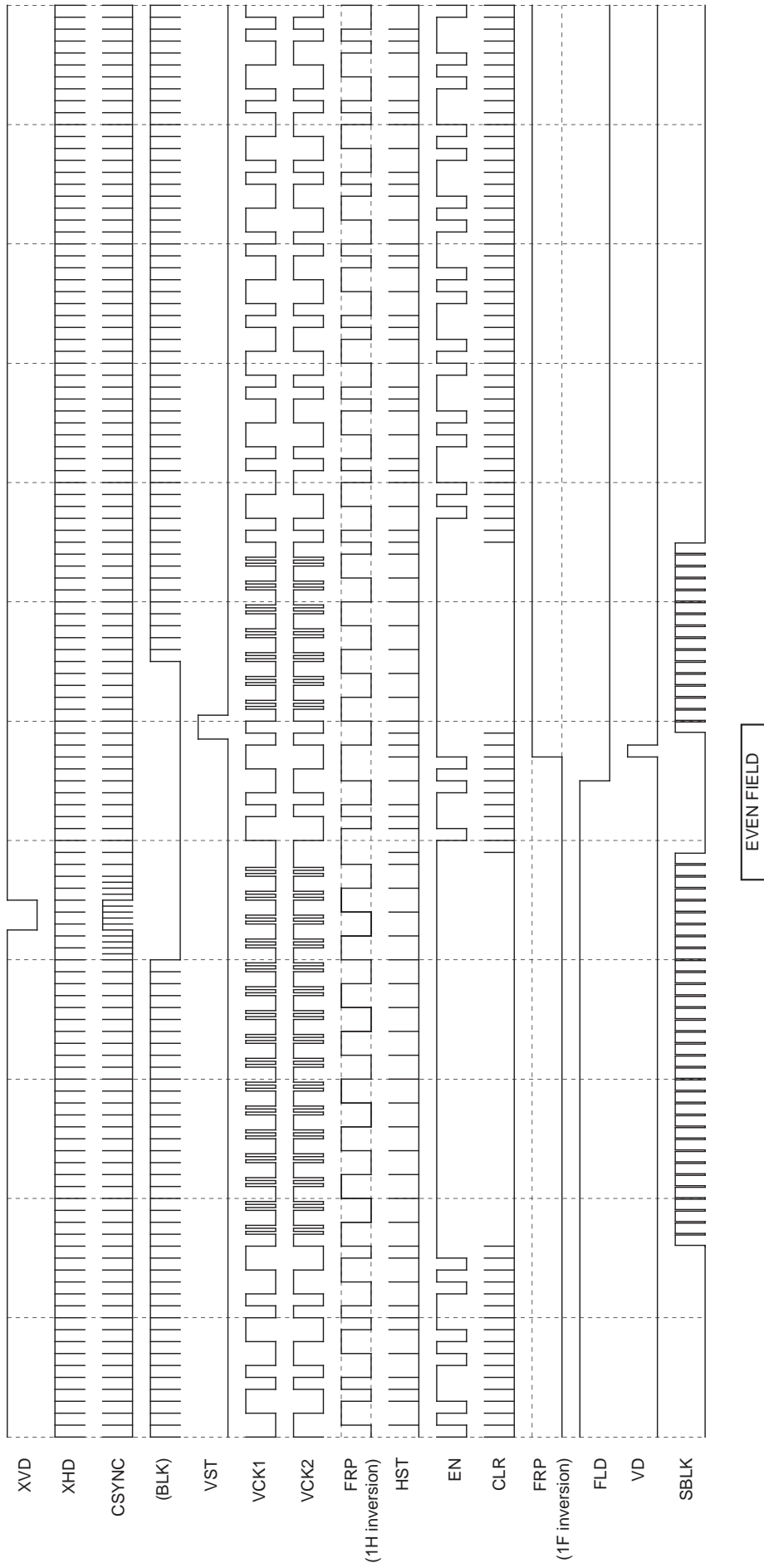

Note) The fourth row of the timing chart "BLK" is a pulse indicated as a reference and is not a pulse output from pins.
FRP polarity is not specified for each line and field.

AC Driving for No Signal

HST1, HST2, HCK1, HCK2, FRP, VCK1, VCK2, XCLP, HD, VD, and VST are made to run free so that the LCD panel is AC driven even when there are no horizontal and vertical sync signals from the XHD and XVD pins.

During this time, the PLL counter is made to run free because the horizontal sync separation circuit stops. In addition, the auxiliary V counter is used to create the reference pulse for generating VD and VST because the vertical sync separation circuit is also stopped.

The cycle of this V counter is designed to be 269H for NTSC and 321H for PAL. However, when there is no vertical sync signal for 301H (NTSC) or 360H (PAL), the no signal state is assumed and the free running VD and VST pulses are generated from the next field.

The RPD is kept at high impedance when there is no signal in order to prevent the AFC circuit from causing phase errors due to phase comparison.

AFC Circuit (702/1050fh Generation)

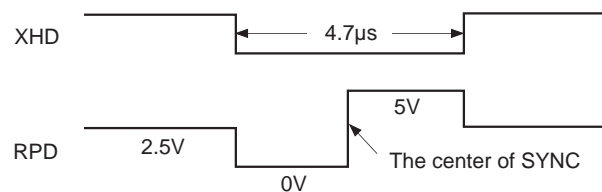

A fully synchronized AFC circuit is built in. PLL error detection signal is generated at the following timing.

The phase comparison output of the entire bottom of XHD and the internal H counter becomes RPD. RPD output is converted to DC error with the lag-lead filter, and then it changes the varicap capacitance and the oscillating frequency is stabilized at 702, 1050fh in the LCX005BK/BKB, LCX009AK/AKB.

Application Circuit

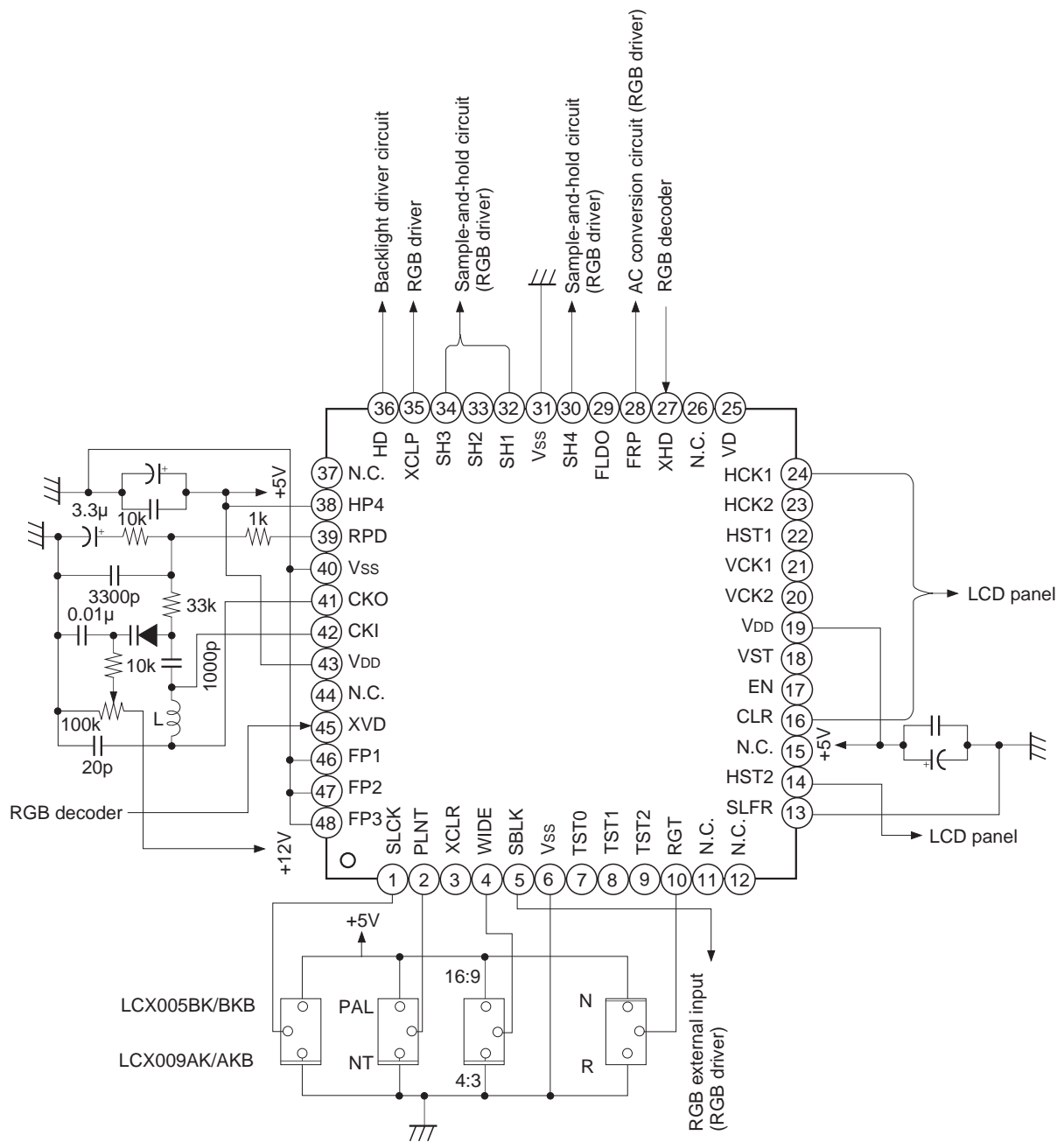

Reference examples of L value: when using LCX009AK/AKB 4.7µH Recommended varicap: 1T369 (SONY)
 when using LCX005BK/BKB 10µH

Application circuits shown are typical examples illustrating the operation of the devices. Sony cannot assume responsibility for any problems arising out of the use of these circuits or for any infringement of third party patent and other right due to same.

Package Outline

Unit: mm

48PIN LQFP (PLASTIC)

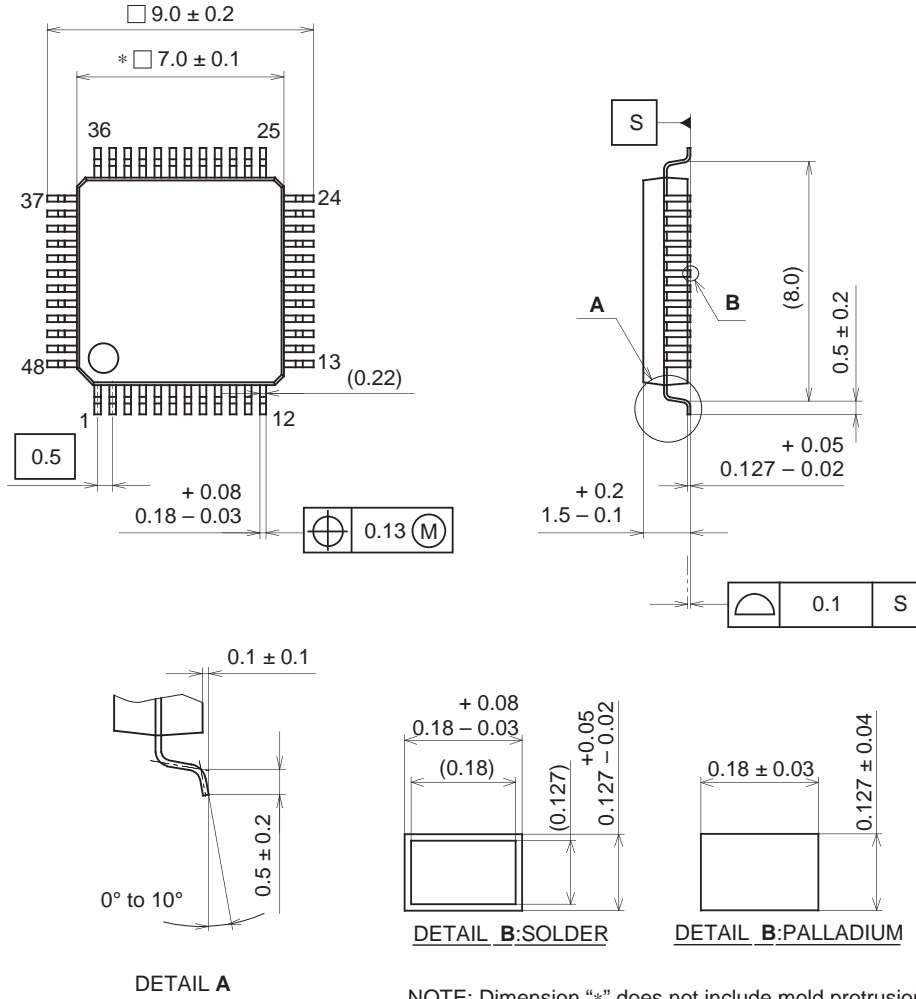

SONY CODE	LQFP-48P-L01
EIAJ CODE	LQFP048-P-0707
JEDEC CODE	_____

PACKAGE STRUCTURE

PACKAGE MATERIAL	EPOXY RESIN
LEAD TREATMENT	SOLDER/PALLADIUM PLATING
LEAD MATERIAL	42/COPPER ALLOY
PACKAGE MASS	0.2g